

VERTIFLO

The Vertical Pump Specialists

PUMPS FOR INDUSTRY

CONTENTS:

Introduction & User List

Product Overview

Vertical Process Pumps Series 600

Vertical Sewage Pumps Series 700

Vertical Sump Pumps Series 800

Vertical Vortex Pumps Series 900

Vertical Cantilever Pumps Series 1100 and 1200

**Horizontal End Suction
Pumps-Centrifugal Series 1300 and 1400**

Horizontal End Suction
Pumps-Vortex Series 1500 and 1600

Horizontal Self-priming
Pumps- Centrifugal Series 2100

Engineering Sample Specifications

VERTIFLO SERIES 1300, MODEL 1312

Quality Design Features Assure Long, Trouble-Free Service

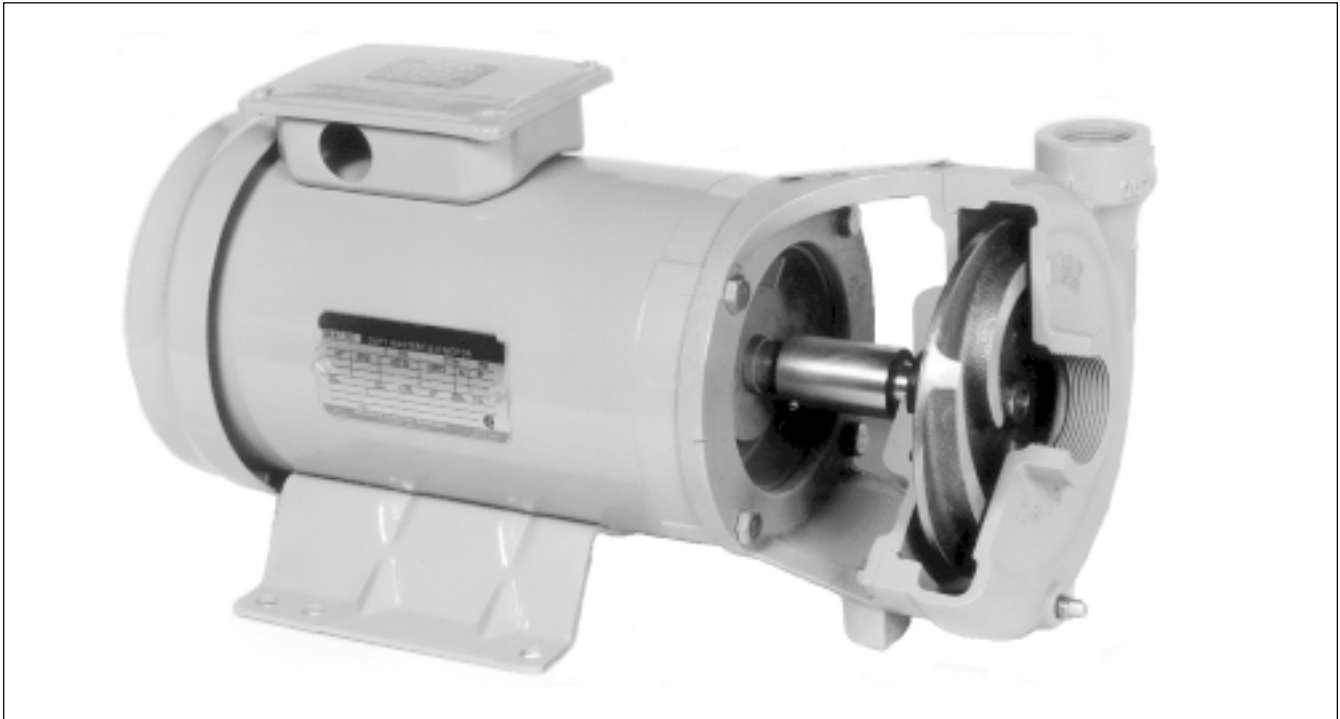
**WIDE RANGE OF APPLICATIONS:**

- General Pumping
- Process
- Chemicals
- Deionized Water
- Wash Systems
- OEM

CAPABILITIES:

- Capacities to 240 GPM
- Heads To 160 Feet TDH
- 1750 and 3500 RPM

CONSTRUCTION:

- All Iron
- Bronze Fitted
- 316 Stainless Steel Fitted
- All 316 Stainless Steel

FEATURES:

- Close-Coupled Design Saves Installation Space
- Back Pull-Out Design
- Standard NEMA C-Face Motor
- Standard Size Mechanical Seal
- Pump Volute, Impeller and Mounting Bracket are Heavy Cast Metal
- Semi-Open Impeller
- Threaded NPT Suction and Discharge Connections

Model 1312 horizontal motor-mounted end suction pumps are designed for use with NEMA standard C-face electric motors. This rugged and dependable pump will provide many years of dependable service.

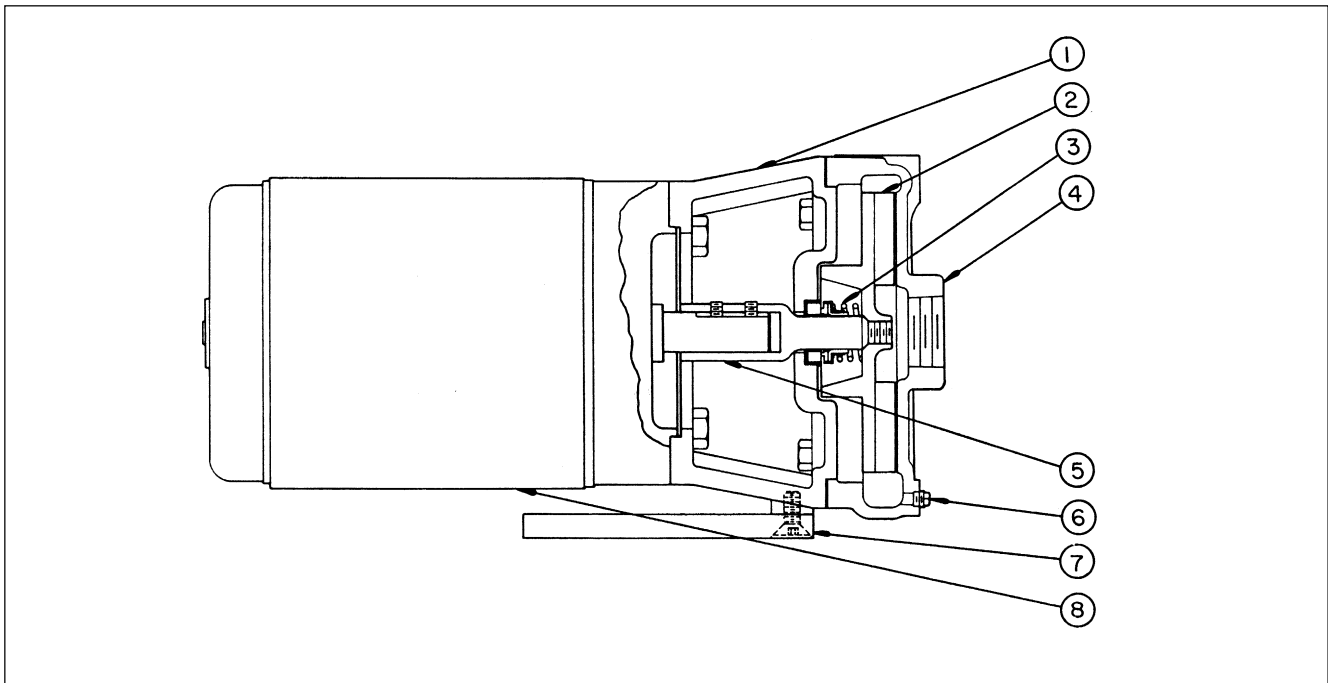

CUSTOMER Benefits

1. Motor Support and Seal Housing

one-piece casting

- Assures positive alignment of motor and pump with registered fits

2. Impeller

semi-open design with balance hub. Secured to shaft by taper and threads.

- High quality - smooth performance
- Easily removed

3. Mechanical Seal

Self-aligning design

- No adjustment required

4. Casing

Back pull-out design. Discharge orientation options.

- Rotating element easily removed - casing remains in piping
- Casing may be rotated in 90° increments to accommodate various piping requirements

5. Shaft

316 stainless steel material. Standard with taper and threads.

- Long lasting and replaceable

6. Support Foot Adaptor (optional)

- Bolt-on type design for versatility

7. C-Face Motor

Standard

- Readily available

VERTIFLO PUMP COMPANY Performance Curves

Series 1300 / Model 1312 Size 1 1/2 X 1 X 6

1750 RPM

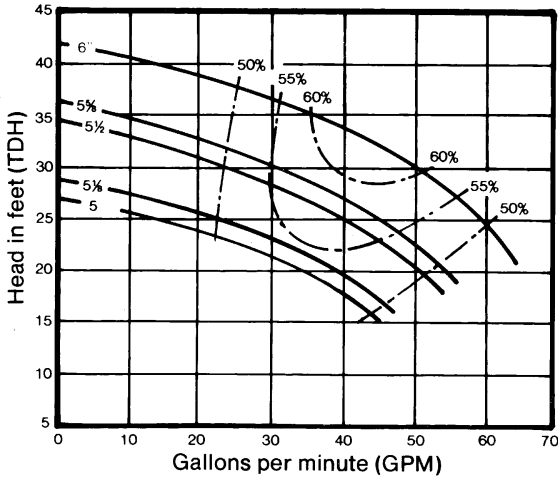

HP	SF	DIA
3/4	1.15	6
	1.00	6
1/2	1.15	5 5/8
	1.00	5 1/2
1/3	1.15	5 1/8
	1.00	5

3500 RPM

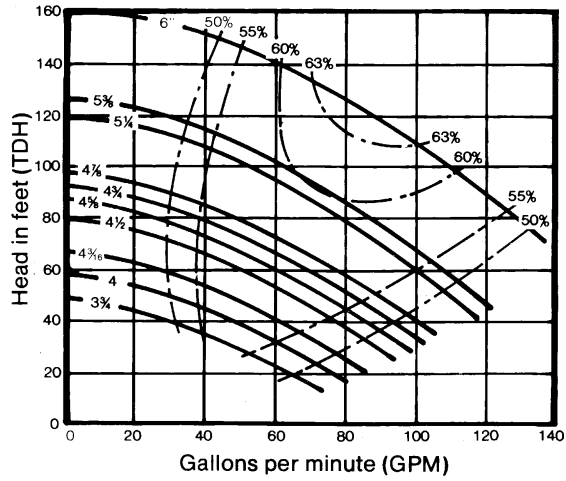

HP	SF	DIA	HP	SF	DIA
5	1.15	6	1 1/2	1.15	4 5/8
	1.00	6		1.00	4 1/2
3	1.15	5 3/8	1	1.15	4 3/16
	1.00	5 1/4		1.00	4
2	1.15	4 7/8			
	1.00	4 3/4			

Series 1300 / Model 1312 Size 2 X 1 1/2 X 6

1750 RPM

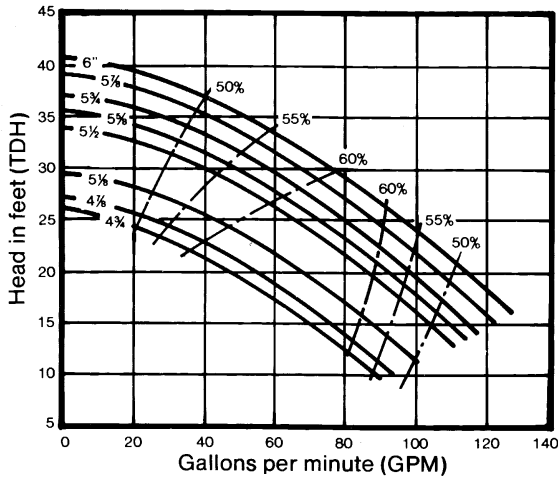

HP	SF	DIA	HP	SF	DIA
1 1/2	1.15	6	3/4	1.15	5 5/8
	1.00	6		1.00	5 1/2
1	1.15	5 7/8	1/2	1.15	5 1/8
	1.00	4 7/8		1.00	4 7/8

3500 RPM

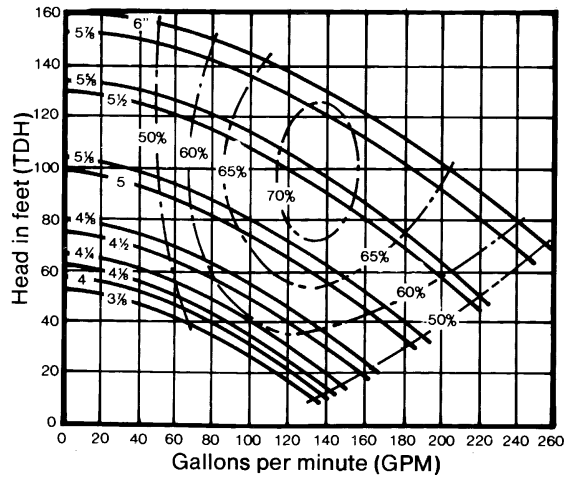

HP	SF	DIA	HP	SF	DIA
7 1/2	1.15	6	2	1.15	4 5/8
	1.00	5 7/8		1.00	4 1/2
5	1.15	5 5/8	1 1/2	1.15	4 1/4
	1.00	5 1/2		1.00	4 1/8
3	1.15	5 1/8	1	1.15	4
	1.00	5		1.00	3 7/8

Performance at Casing Discharge Flange

Curves Show Performance with Liquid Having Specific Gravity 1.0 Viscosity • 30 SSU

CUSTOMER _____ CUSTOMER NO. _____

PROJECT _____

ENGINEER _____

CONTRACTOR _____

CONDITIONS: _____ GPM _____ TDH _____ HP _____ EFF% _____ IMP. DIA _____

1300

1300 Series / Model 1312

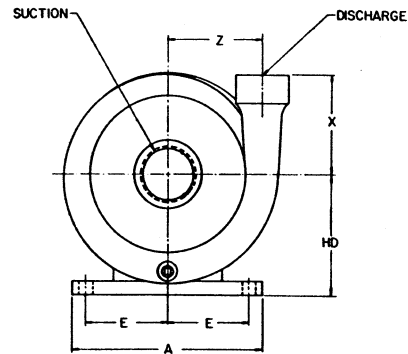
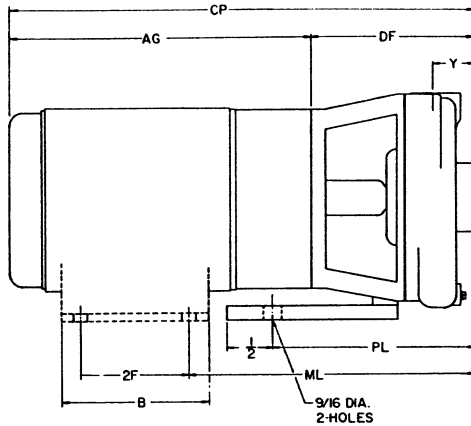

Size 1 1/2 x 1 x 6

RPM	HP	PUMP FOOT	SUC	DIS	A	AG	B	CP	E	2F	DF	H*	HD	ML	PL	X	Y	Z
1750	1/8	NOT REQD	1 1/2" NPT	1" NPT	6.50	9.29	4.25	15.17	2.44	3.00	5.88	NA	4.38	8.75	5.50	3.75	1.25	3.50
	1/2					9.94		15.82										
	3/4					9.29		15.19										
1	10.29					16.17												
3500	1					11.06	16.94	5.94	2.75	5.00		.44	4.50					
	1 1/2					12.07	17.82											
	2					13.68	19.56											
	3																	
	5																	

*Dimensions are for TEFC motors only
Optional pump foot shown for motors less feet

Size 2 x 1 1/2 x 6

RPM	HP	PUMP FOOT	SUC	DIS	A	AG	B	CP	E	2F	DF	H*	HD	ML	PL	X	Y	Z
1750	1/2	NOT REQD	2" NPT	1 1/2" NPT	6.50	9.29	4.25	15.67	2.44	3.00	6.38	NA	4.38	9.25	6.00	3.88	1.63	3.63
	3/4					9.94		16.32										
	1					10.19		16.57										
	1 1/2					10.29	16.67											
3500	1 1/2					11.06	17.44	5.94	2.75	5.00		.44	4.50					
	2					12.07	18.32											
	3					13.68	20.06											
	5					15.18	21.56											
	7 1/2																	

*Dimensions are for TEFC motors only. NA= not applicable
Optional pump foot shown for motors less feet

Not for construction unless certified, some dimensions may vary $\pm 1/2"$. Pump Construction: _____

CUSTOMER _____ CUSTOMER NO. _____
 PROJECT _____ SERIAL NO. _____
 ENGINEER _____ LOCATION _____
 CONTRACTOR _____
 PUMP Model Size Curve No. GPM Head SP. GR. @Temp.
 DATA _____
 MOTOR Mfr. HP RPM Volt-Phase-Cycle Frame ENC. Furnished by Mounted by
 DATA _____
 Shop Order _____ Certified by _____ Date _____

VERTIFLO SERIES 1300

Quality Design Features Assure Long, Trouble-Free Service

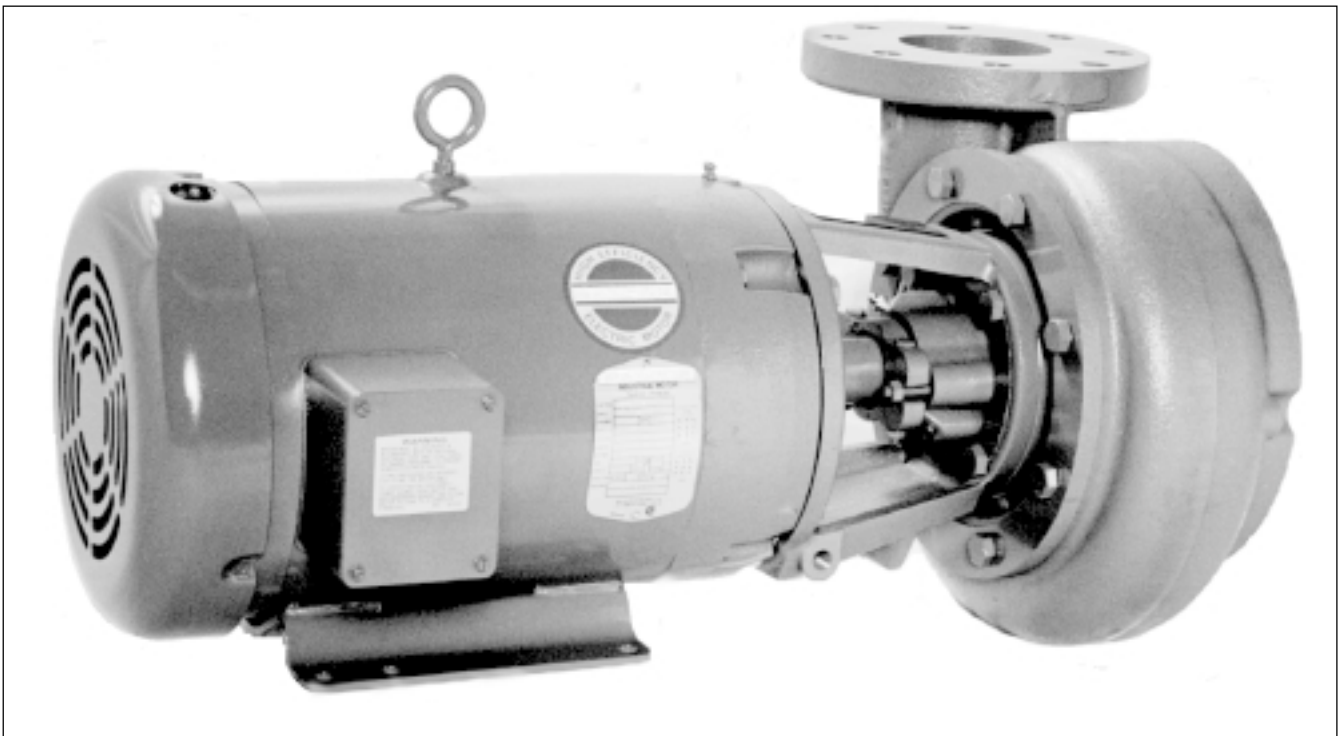
**WIDE RANGE OF APPLICATIONS:**

- Industrial Process
- Pollution Control
- General Pumping
- Spray Systems
- Deionized Water
- Waste Water
- Clear Liquids
- Corrosive Liquids
- Chemicals
- Acids

CAPABILITIES

- Capacities to 3600 GPM
- Heads To 275 Feet TDH
- Temperature to 250° F
- Back Pull-Out Construction
- Semi-Open Impeller
- Packing or Mechanical Seal

CONSTRUCTION:

- Cast Iron
- 316 Stainless Steel Fitted
- All 316 Stainless Steel
- Alloy 20
- CD4MC_u

Series 1300 horizontal close-coupled end suction pumps are designed for use with any NEMA Standard JP Shaft Motor. VERTIFLO's close-coupled pumps are designed with back pull-out feature. This important feature allows for easy inspection or service/ maintenance (if ever needed) without disturbing the piping to the pump: An important cost saving feature. Packing or various mechanical seal arrangements are available as standard options of this rugged, dependable product.

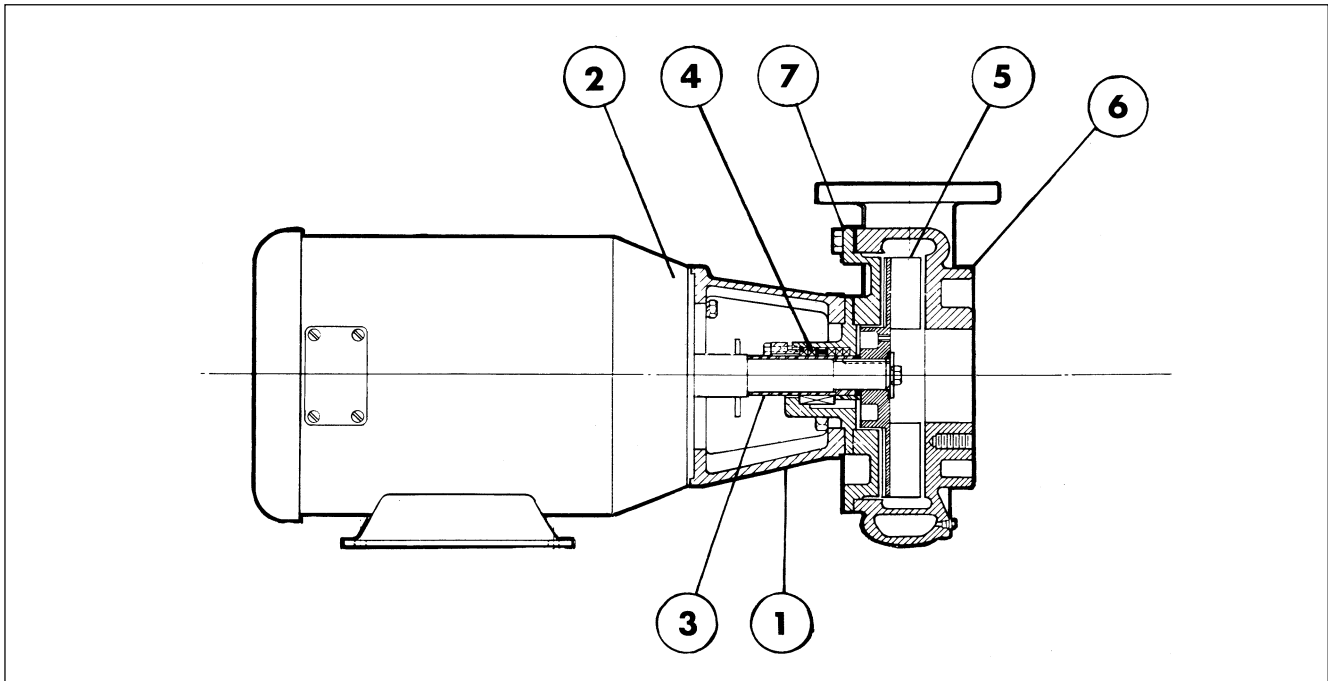

1. Mounting Bracket

Rugged cast iron design which assures a solid, dependable pump installation and operation. Three brackets fit all pump sizes.

2. Motor

NEMA standard JP shaft extension allows for easy interchangeability to packing, standard mechanical seal or optional single or double mechanical seals of various designs and materials of construction.

3. Shaft Sealing

Packed arrangement utilizes a 2-piece split gland, slinger, Teflon® split lantern ring and 5-ring packing set. Grease lubrication is standard with product or water flush available. Wide choice of John Crane and Durametallic mechanical seals of various configurations and materials are optional.

4. Shaft Sleeve

316 stainless steel is standard. Positively driven and gasketed, protecting motor shaft from liquid being pumped.

E.I DuPont registered®

5. Impeller

Semi-open design which accommodates passage of solids or fines. All impellers have holes near the impeller hub which reduce thrust load and pressure in the packing or seal area. Wiping vanes reduce axial loading and prevent dirt from entering the sealing area. Impeller is keyed to shaft, and an impeller locking screw assures positive attachment.

6. Casing

High efficiency volute design. 4X3X10 and larger sizes are double volute, containing a splitter, which reduces bearing loading and shaft deflection; thus extending bearing and packing or mechanical seal life. All suction and discharge openings are flanged for installation ease and integrity.

7. Back Pull-Out

All pumps* are designed with back pull-out feature which allows for removal of all pump rotating components without disturbing the piping connections.

*except size 2 X 1 1/2 X 12

Standard

- All iron construction
- 316 stainless steel shaft sleeve
- Semi-open impeller
- Back pull-out design
- Packed stuffing box or mechanical seal
- Flanged suction and discharge on all pump sizes
- NEMA standard JP shaft motor

Options

- 316 stainless steel impeller
- All 316 stainless steel, Alloy 20, CD4MC_u
- Single or double mechanical seal (various materials)
- Product or fresh water flush to packing or mechanical seal
- Teflon® packing (standard in s.s. and alloy units)
- ODP, TEFC

Design Details	Model 1320	Model 1326	Model 1334
Rotation from driver end	CW	CW	CW
Outside diameter of shaft sleeve	1.250	1.625	2.125
Shaft diameter at impeller	0.875	1.250	1.750

VERTIFLO PUMP COMPANY Performance Curves

Curve PV-1525

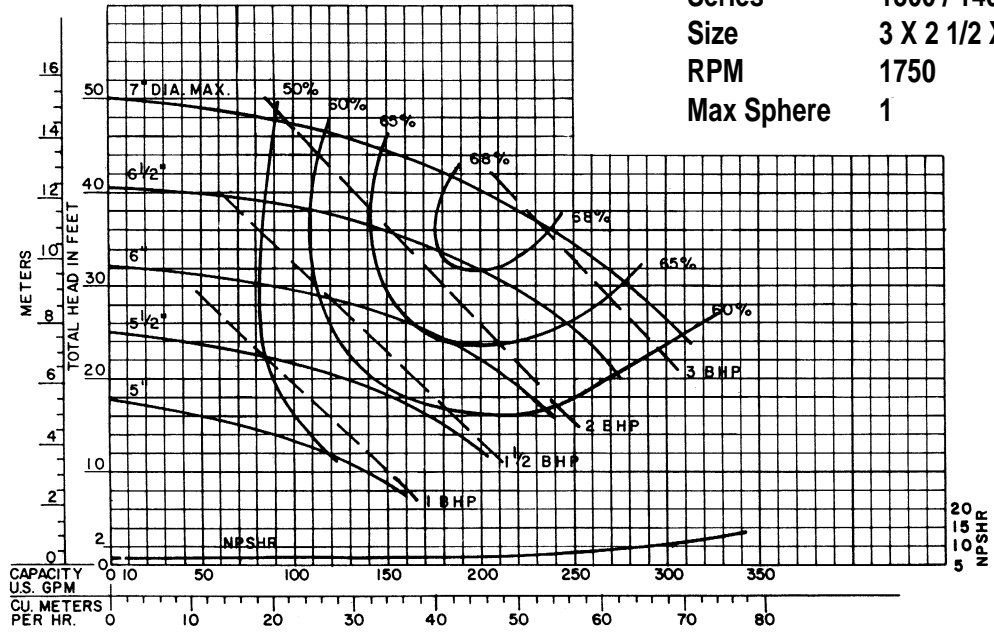

Curve RV-1525

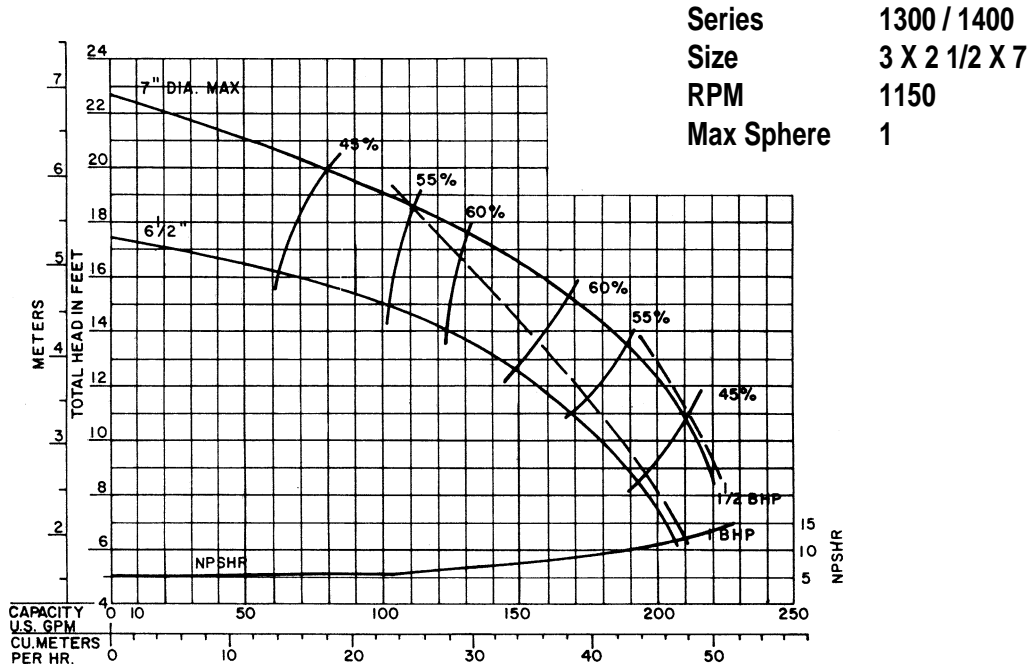

Performance at Casing Discharge Flange

Curves Show Performance with Liquid Having Specific Gravity 1.0 Viscosity • 30 SSU

CUSTOMER _____ CUSTOMER NO. _____

PROJECT _____

ENGINEER _____

CONTRACTOR _____

CONDITIONS: _____ GPM _____ TDH _____ HP _____ EFF% _____ IMP. DIA _____

VERTIFLO PUMP COMPANY Performance Curves

Curve AS-1610

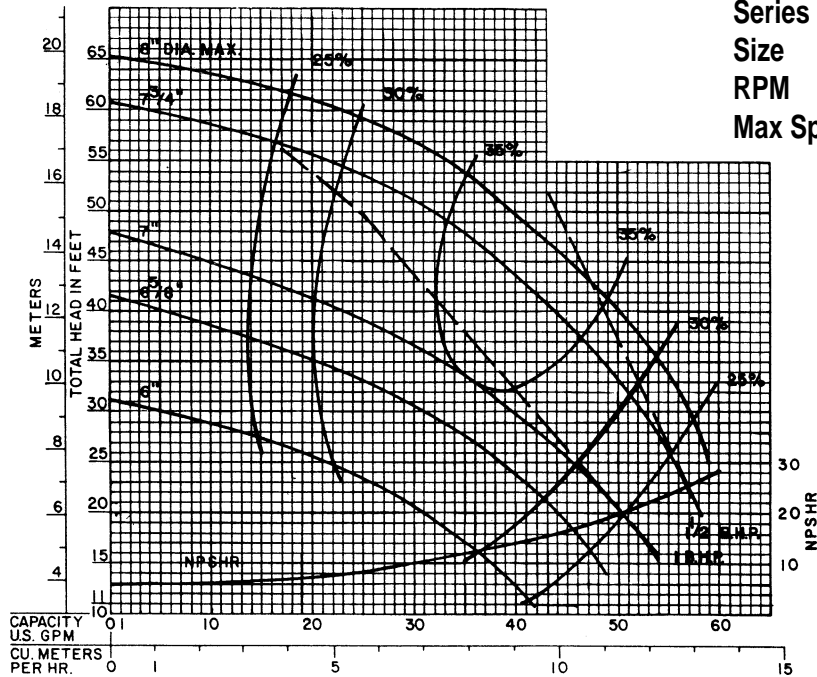

Series 1300 / 1400
 Size 1 1/2 X 1 X 8
 RPM 1750
 Max Sphere 1/4

Curve BS-1610

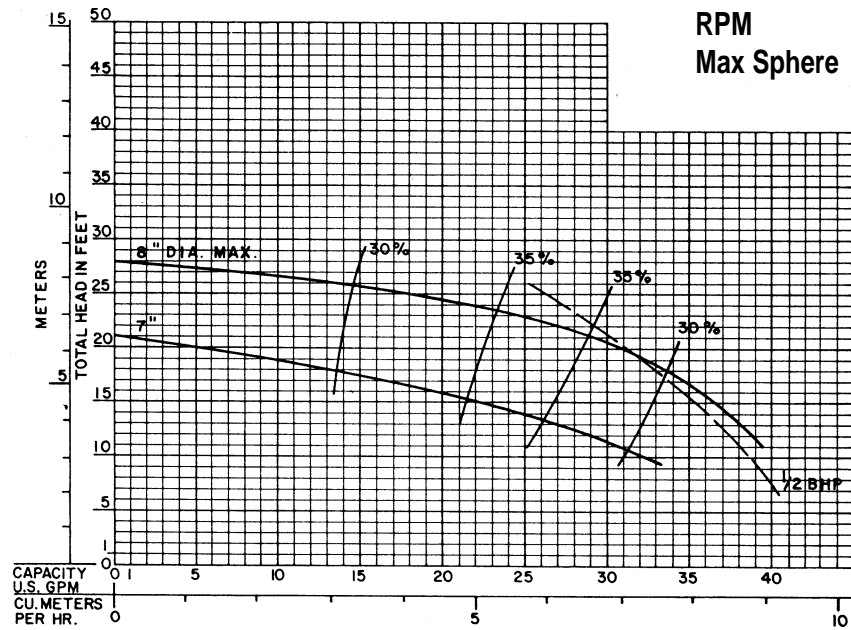

Series 1300 / 1400
 Size 1 1/2 X 1 X 8
 RPM 1150
 Max Sphere 1/4

1300

Performance at Casing Discharge Flange
 Curves Show Performance with Liquid Having Specific Gravity 1.0 Viscosity • 30 SSU

CUSTOMER _____ CUSTOMER NO. _____
 PROJECT _____
 ENGINEER _____
 CONTRACTOR _____
 CONDITIONS: _____ GPM _____ TDH _____ HP _____ EFF% _____ IMP. DIA _____

VERTIFLO PUMP COMPANY Performance Curves

Curve AS-1612

Series 1300 / 1400
 Size 1 1/2 X 1 1/4 X 8
 RPM 1750
 Max Sphere 5/16

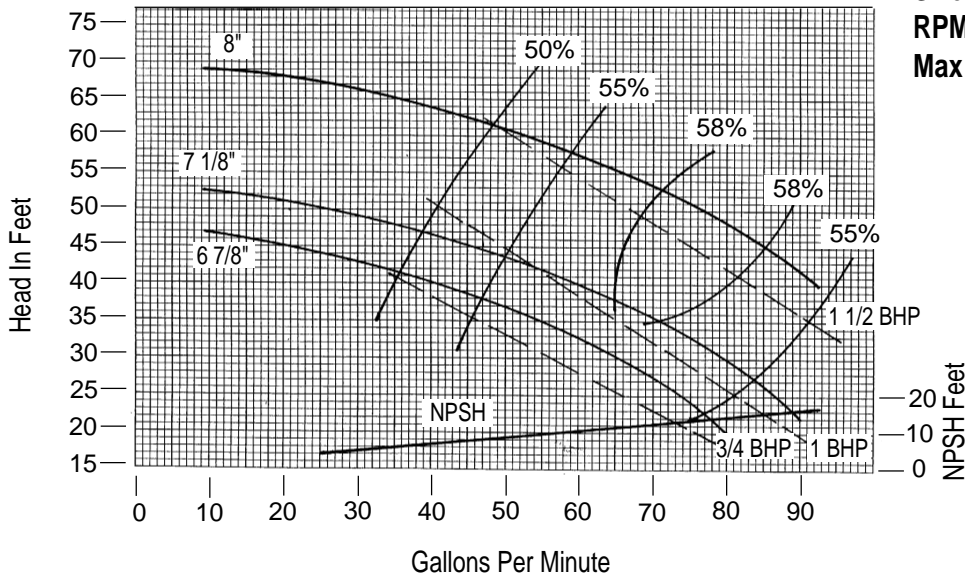

Curve BS-1612

Series 1300 / 1400
 Size 1 1/2 X 1 1/4 X 8
 RPM 1150
 Max Sphere 5/16

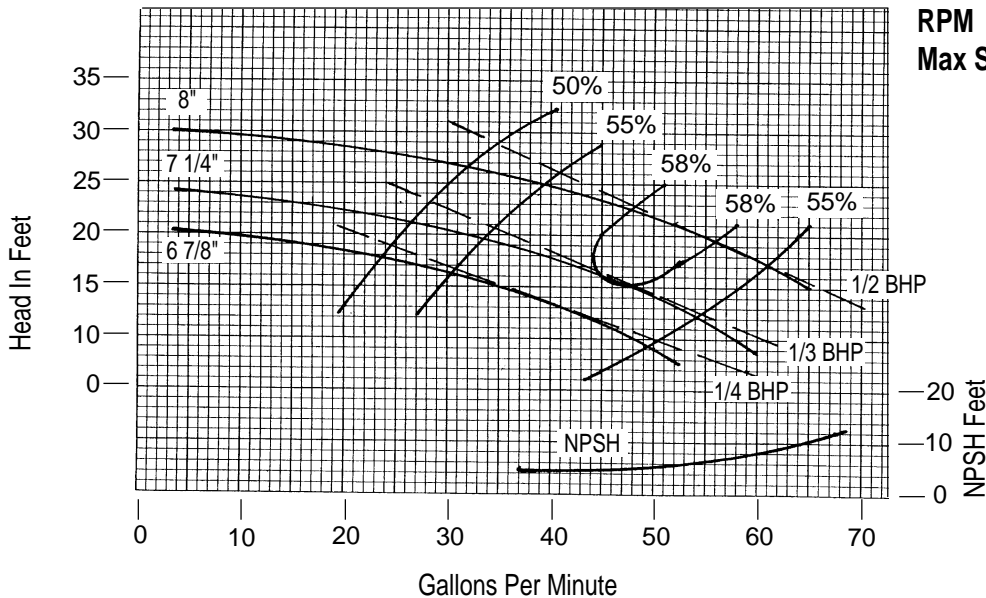

Performance at Casing Discharge Flange

Curves Show Performance with Liquid Having Specific Gravity 1.0 Viscosity • 30 SSU

CUSTOMER _____ CUSTOMER NO. _____

PROJECT _____

ENGINEER _____

CONTRACTOR _____

CONDITIONS: _____ GPM _____ TDH _____ HP _____ EFF% _____ IMP. DIA _____

VERTIFLO PUMP COMPANY Performance Curves

Curve BS-1615

Series 1300 / 1400
 Size 2 X 1 1/2 X 8
 RPM 1750
 Max Sphere 7/16

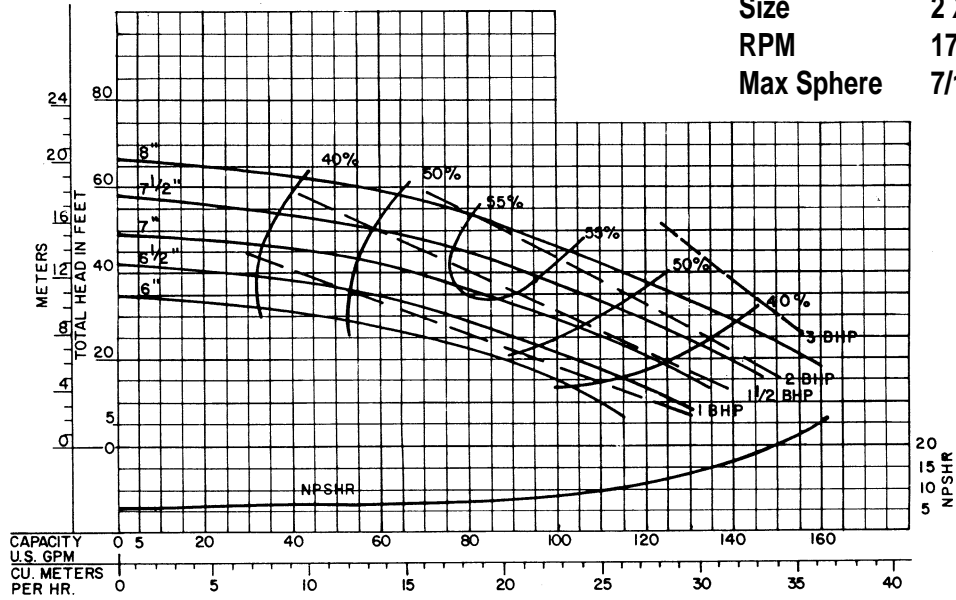

Curve CS-1615

Series 1300 / 1400
 Size 2 X 1 1/2 X 8
 RPM 1150
 Max Sphere 7/16

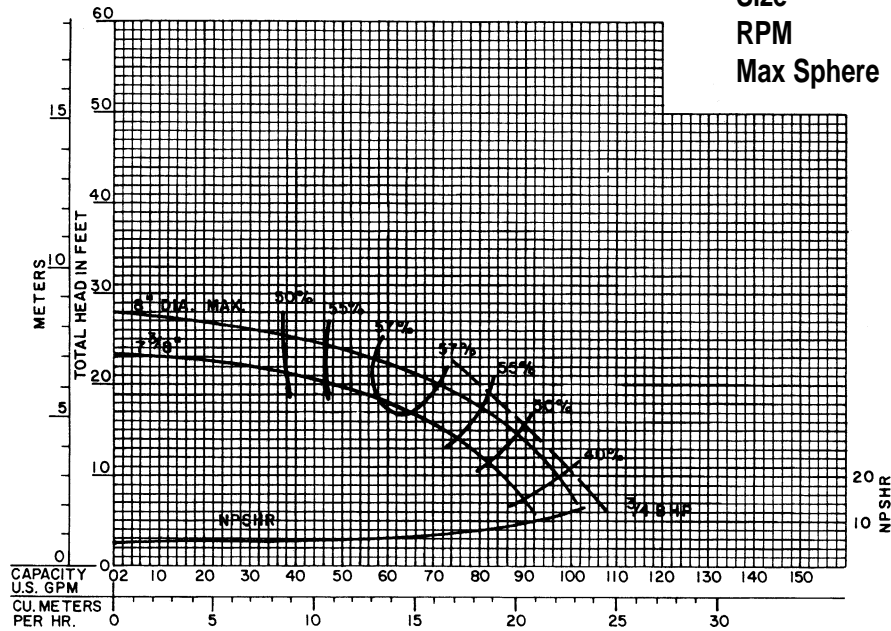

1300

Performance at Casing Discharge Flange

Curves Show Performance with Liquid Having Specific Gravity 1.0 Viscosity • 30 SSU

CUSTOMER _____ CUSTOMER NO. _____

PROJECT _____

ENGINEER _____

CONTRACTOR _____

CONDITIONS: _____ GPM _____ TDH _____ HP _____ EFF% _____ IMP. DIA _____

VERTIFLO PUMP COMPANY Performance Curves

Curve CS-1620

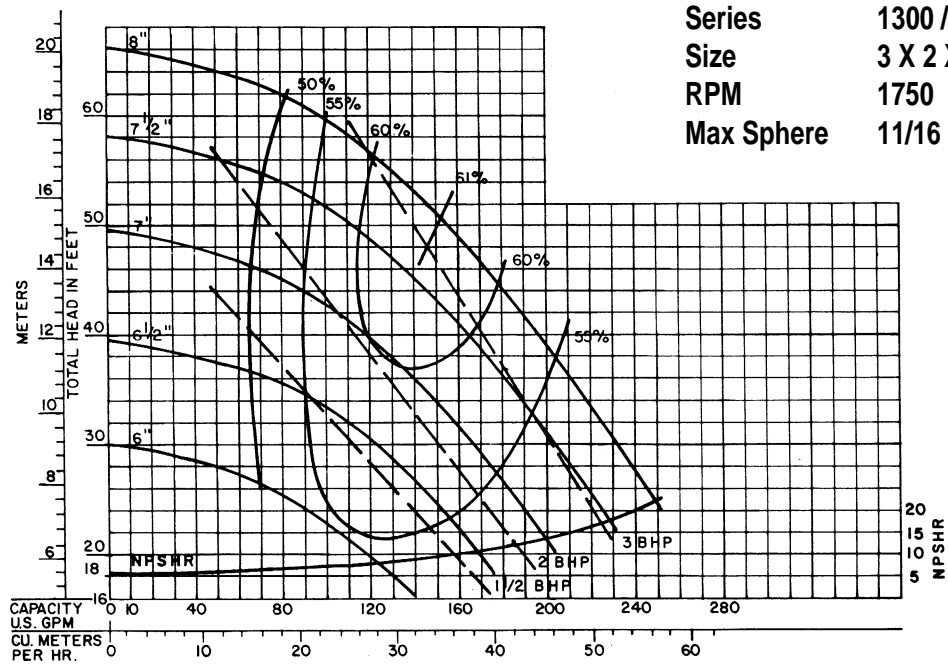

Curve DS-1620

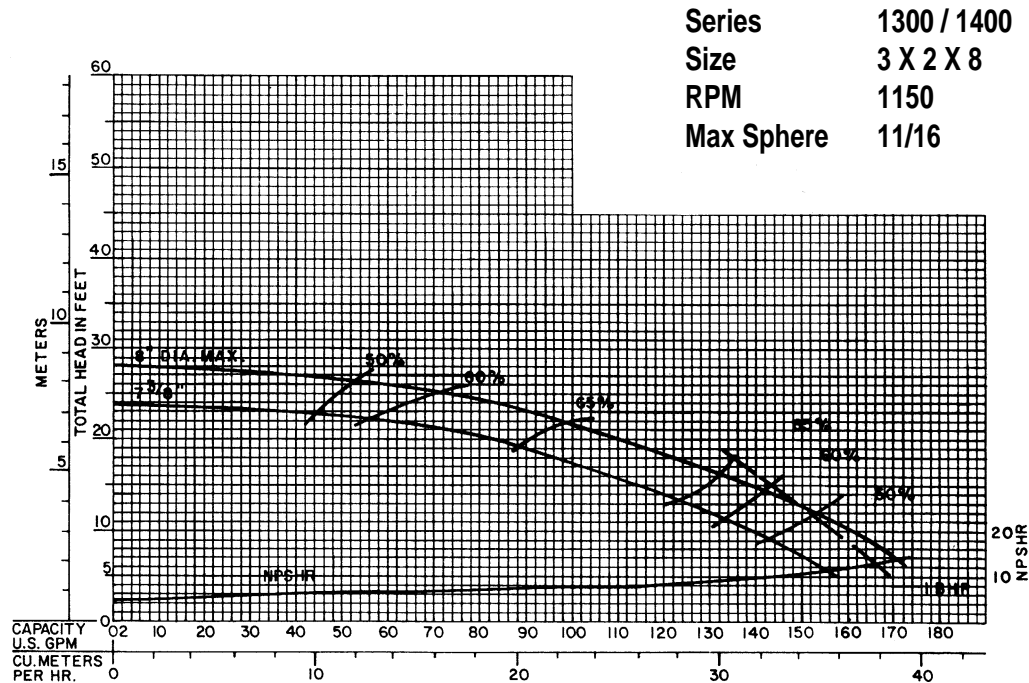

Performance at Casing Discharge Flange

Curves Show Performance with Liquid Having Specific Gravity 1.0 Viscosity • 30 SSU

CUSTOMER _____ CUSTOMER NO. _____

PROJECT _____

ENGINEER _____

CONTRACTOR _____

CONDITIONS: _____ GPM _____ TDH _____ HP _____ EFF% _____ IMP. DIA _____

VERTIFLO PUMP COMPANY Performance Curves

Curve CS-1630

Series 1300 / 1400
 Size 4 X 3 X 8
 RPM 1750
 Max Sphere 1 3/16

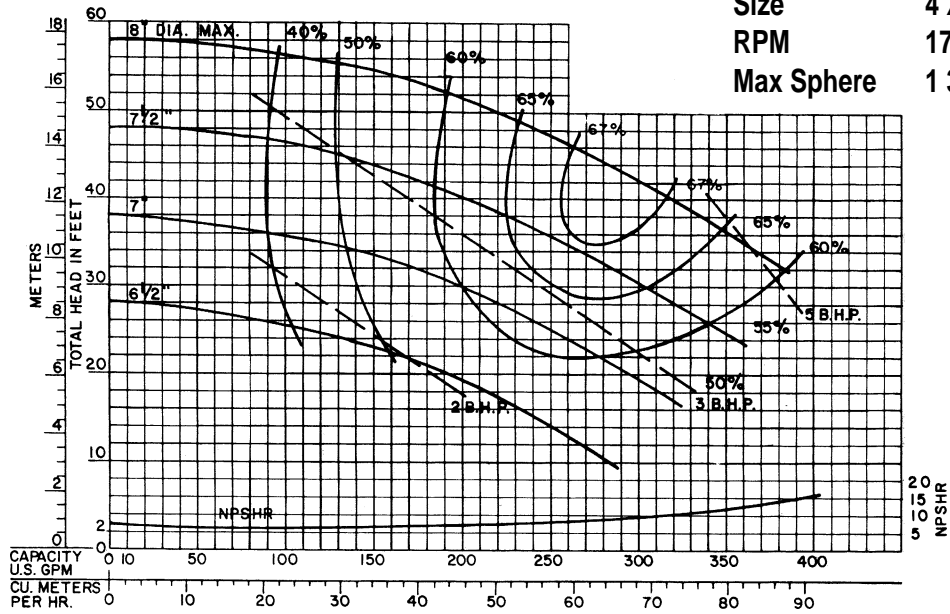

Curve DS-1630

Series 1300 / 1400
 Size 4 X 3 X 8
 RPM 1150
 Max Sphere 1 3/16

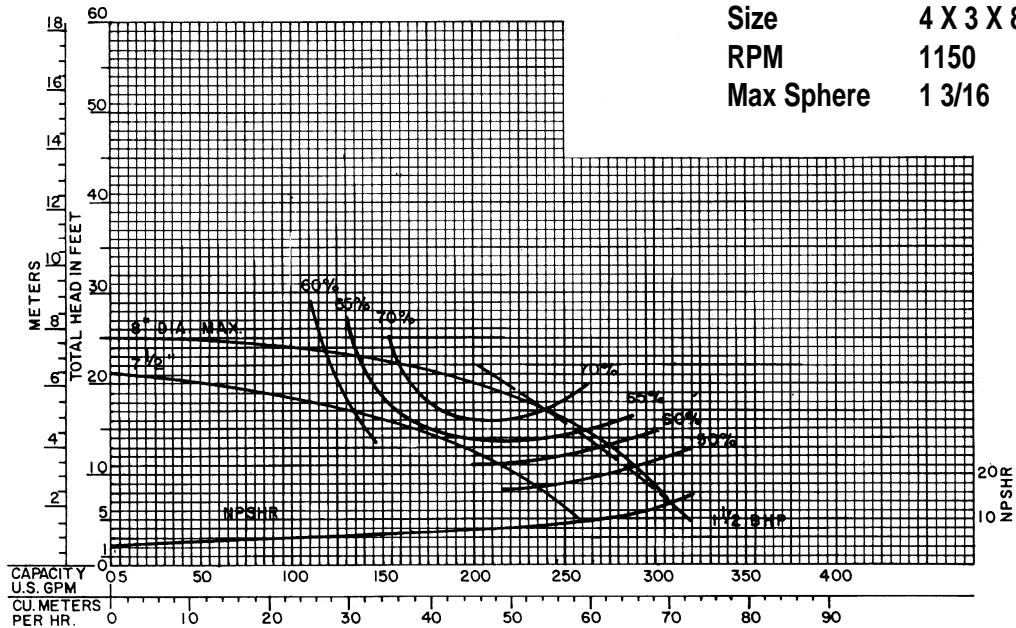

Performance at Casing Discharge Flange

Curves Show Performance with Liquid Having Specific Gravity 1.0 Viscosity • 30 SSU

CUSTOMER _____ CUSTOMER NO. _____

PROJECT _____

ENGINEER _____

CONTRACTOR _____

CONDITIONS: _____ GPM _____ TDH _____ HP _____ EFF% _____ IMP. DIA _____

1300

VERTIFLO PUMP COMPANY Performance Curves

Curve ES-1640

Series 1300 / 1400
 Size 5 X 4 X 8
 RPM 1750
 Max Sphere 15/16

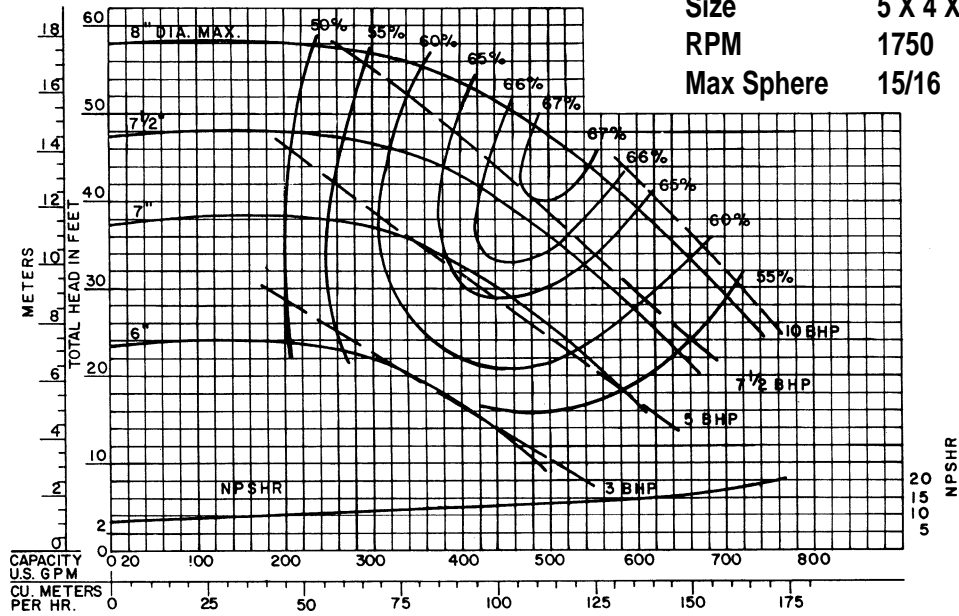

Curve DS-1640

Series 1300 / 1400
 Size 5 X 4 X 8
 RPM 1150
 Max Sphere 15/16

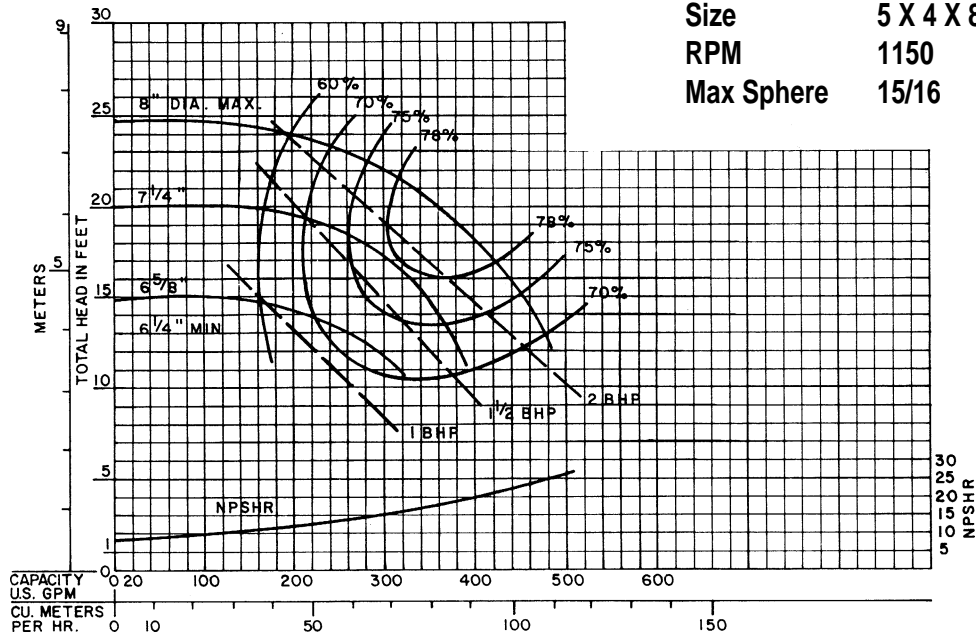

Performance at Casing Discharge Flange

Curves Show Performance with Liquid Having Specific Gravity 1.0 Viscosity • 30 SSU

CUSTOMER _____ CUSTOMER NO. _____

PROJECT _____

ENGINEER _____

CONTRACTOR _____

CONDITIONS: _____ GPM _____ TDH _____ HP _____ EFF% _____ IMP. DIA _____

VERTIFLO PUMP COMPANY Performance Curves

Curve SM-1915

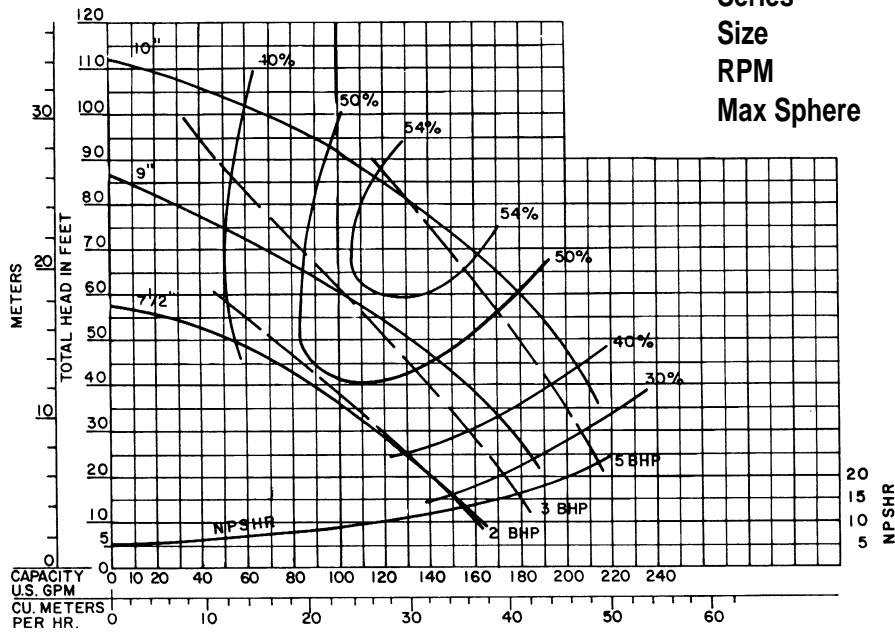

Series 1300 / 1400
 Size 2 X 1 1/2 X 10
 RPM 1750
 Max Sphere 7/16

Curve TM-1915

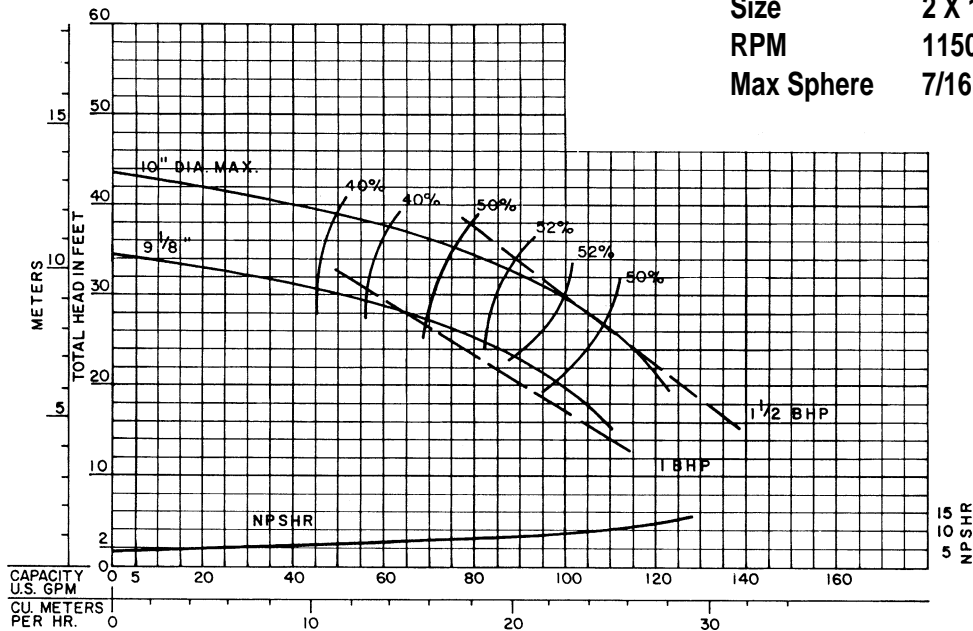

Series 1300 / 1400
 Size 2 X 1 1/2 X 10
 RPM 1150
 Max Sphere 7/16

1300

Performance at Casing Discharge Flange

Curves Show Performance with Liquid Having Specific Gravity 1.0 Viscosity • 30 SSU

CUSTOMER _____ CUSTOMER NO. _____

PROJECT _____

ENGINEER _____

CONTRACTOR _____

CONDITIONS: _____ GPM _____ TDH _____ HP _____ EFF% _____ IMP. DIA _____

VERTIFLO PUMP COMPANY Performance Curves

Curve JM-1720

Series 1300 / 1400
 Size 3 X 2 X 10
 RPM 1750
 Max Sphere 11/16

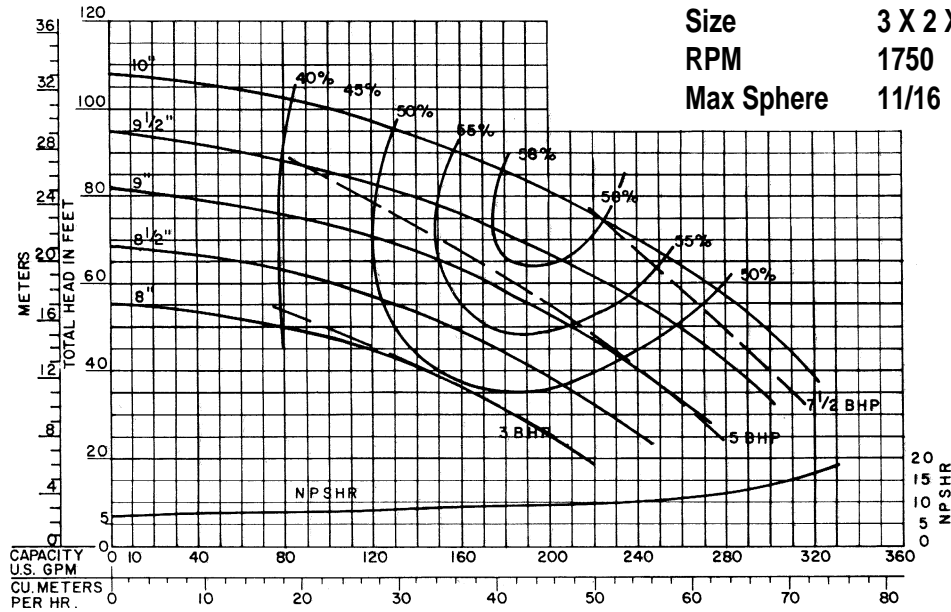

Curve KM-1720

Series 1300 / 1400
 Size 3 X 2 X 10
 RPM 1150
 Max Sphere 11/16

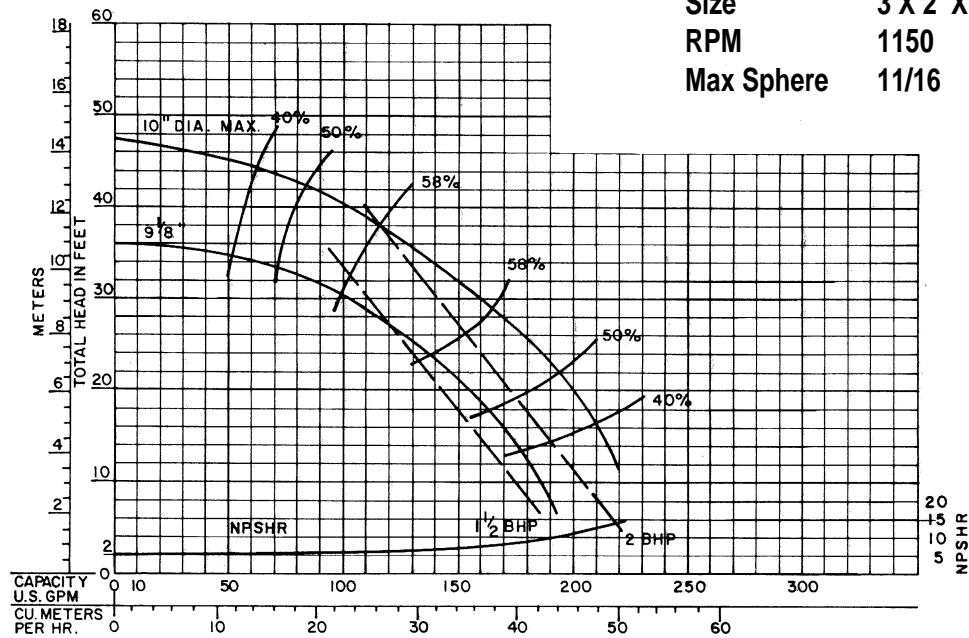

Performance at Casing Discharge Flange

Curves Show Performance with Liquid Having Specific Gravity 1.0 Viscosity • 30 SSU

CUSTOMER _____ CUSTOMER NO. _____

PROJECT _____

ENGINEER _____

CONTRACTOR _____

CONDITIONS: _____ GPM _____ TDH _____ HP _____ EFF% _____ IMP. DIA _____

VERTIFLO PUMP COMPANY Performance Curves

Curve RM-1730

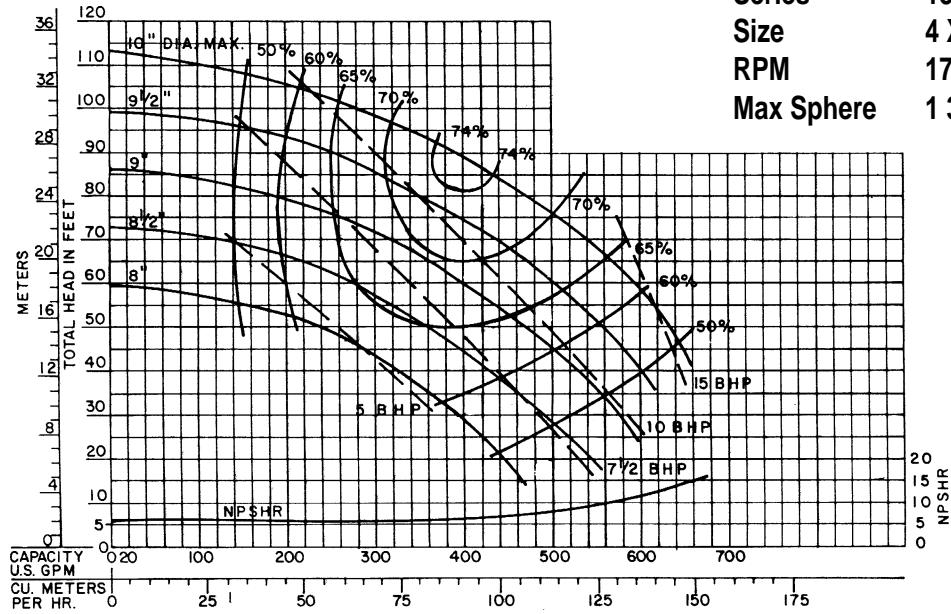

Series 1300 / 1400
 Size 4 X 3 X 10
 RPM 1750
 Max Sphere 1 3/16

Curve SM-1730

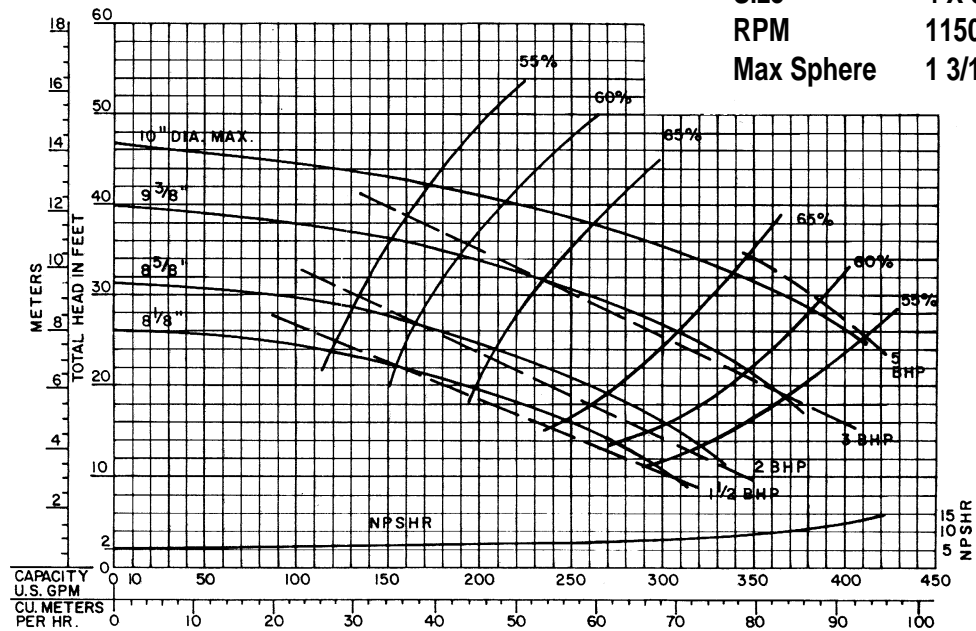

Series 1300 / 1400
 Size 4 X 3 X 10
 RPM 1150
 Max Sphere 1 3/16

1300

Performance at Casing Discharge Flange

Curves Show Performance with Liquid Having Specific Gravity 1.0 Viscosity • 30 SSU

CUSTOMER _____ CUSTOMER NO. _____

PROJECT _____

ENGINEER _____

CONTRACTOR _____

CONDITIONS: _____ GPM _____ TDH _____ HP _____ EFF% _____ IMP. DIA _____

VERTIFLO PUMP COMPANY Performance Curves

Curve TM-1740

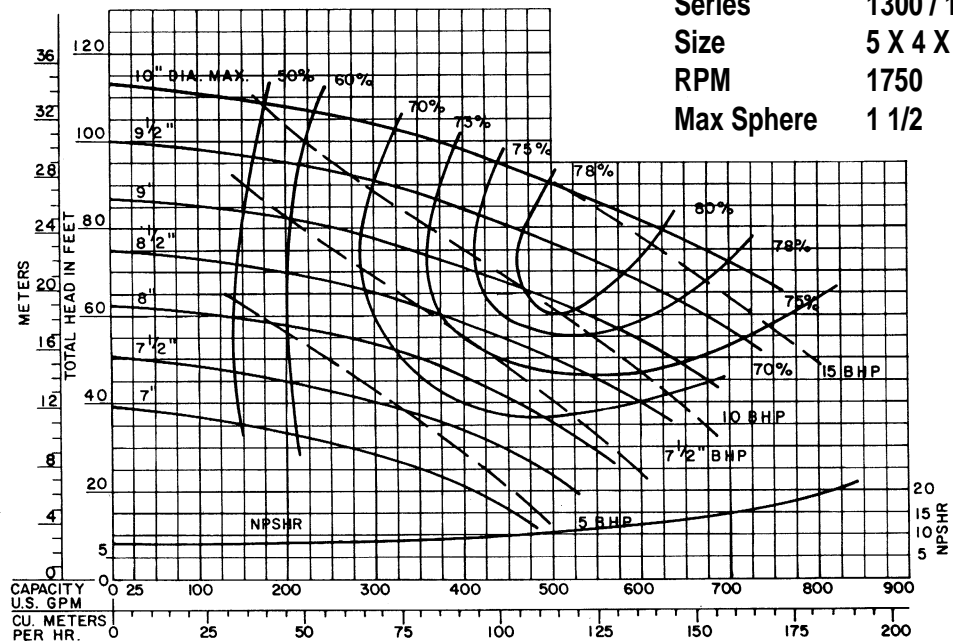

Series 1300 / 1400
 Size 5 X 4 X 10
 RPM 1750
 Max Sphere 1 1/2

Curve UM-1740

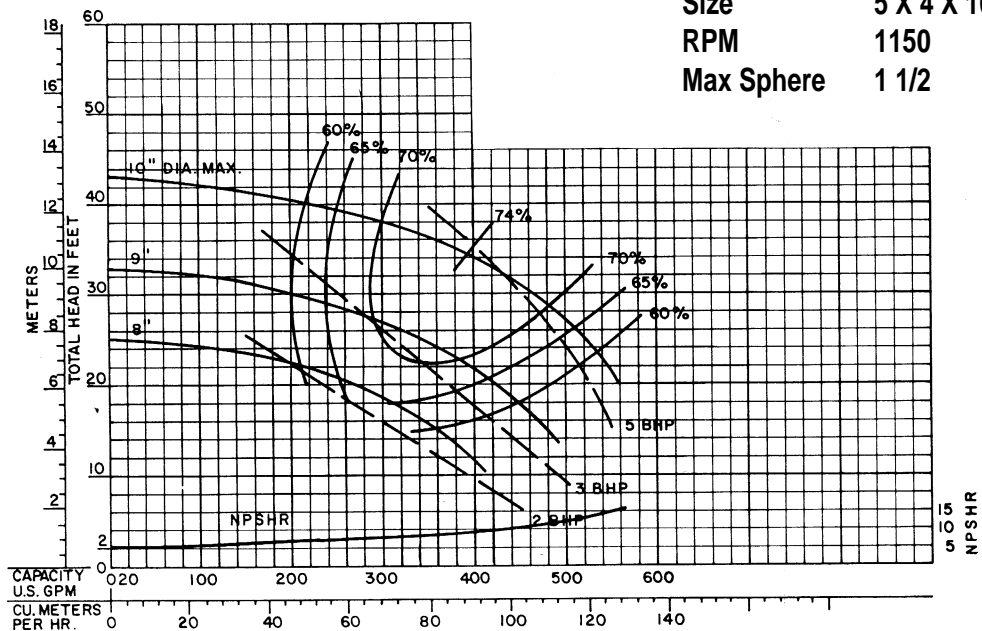

Series 1300 / 1400
 Size 5 X 4 X 10
 RPM 1150
 Max Sphere 1 1/2

Performance at Casing Discharge Flange

Curves Show Performance with Liquid Having Specific Gravity 1.0 Viscosity • 30 SSU

CUSTOMER _____ CUSTOMER NO. _____

PROJECT _____

ENGINEER _____

CONTRACTOR _____

CONDITIONS: _____ GPM _____ TDH _____ HP _____ EFF% _____ IMP. DIA _____

VERTIFLO PUMP COMPANY Performance Curves

Curve UM-1750

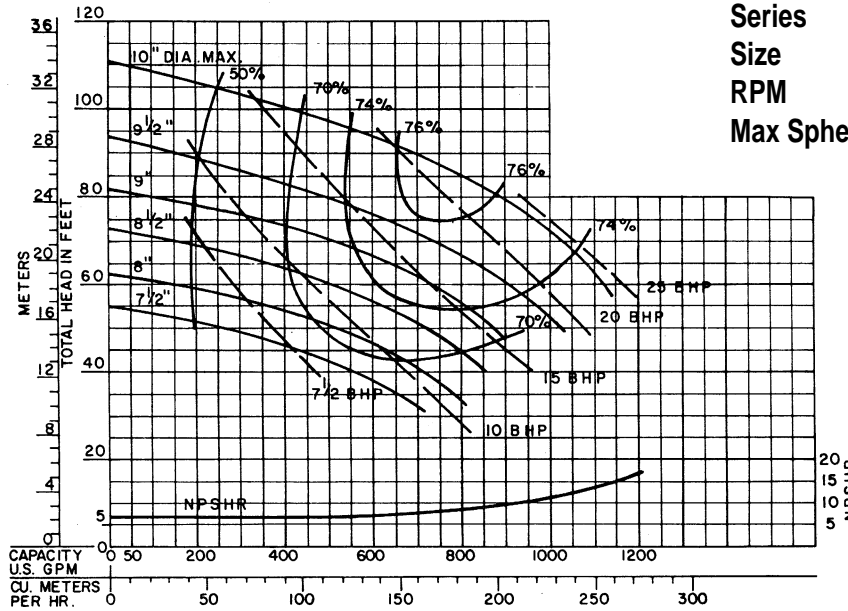

Series 1300 / 1400
 Size 6 X 5 X 10
 RPM 1750
 Max Sphere 1

Curve VM-1750

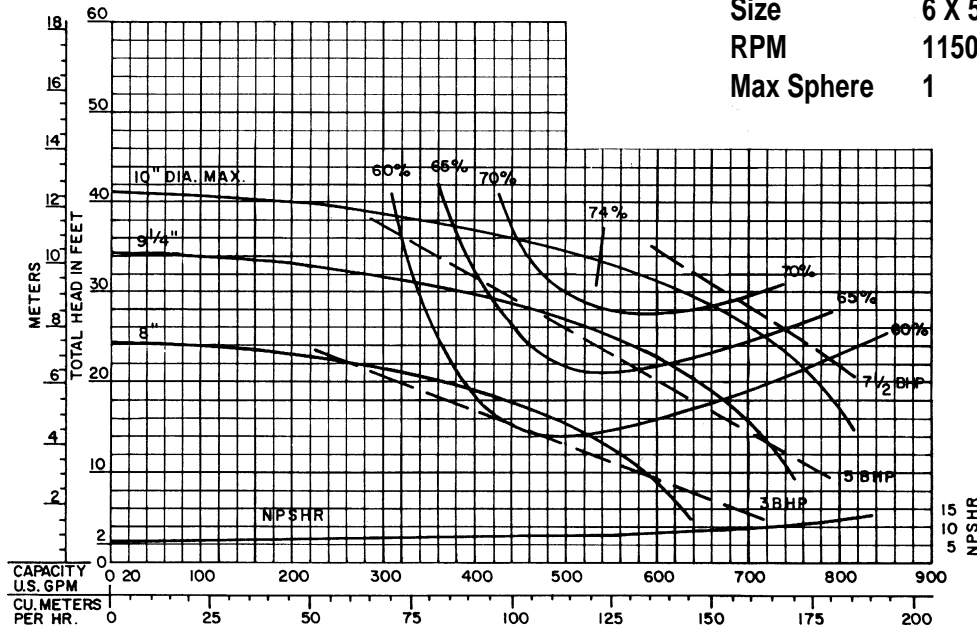

Series 1300 / 1400
 Size 6 X 5 X 10
 RPM 1150
 Max Sphere 1

1300

Performance at Casing Discharge Flange

Curves Show Performance with Liquid Having Specific Gravity 1.0 Viscosity • 30 SSU

CUSTOMER _____ CUSTOMER NO. _____

PROJECT _____

ENGINEER _____

CONTRACTOR _____

CONDITIONS: _____ GPM _____ TDH _____ HP _____ EFF% _____ IMP. DIA _____

VERTIFLO PUMP COMPANY Performance Curves

Curve SM-1750

Series 1300 / 1400
 Size 6 X 5 X 10A
 RPM 1750
 Max Sphere 1 1/2

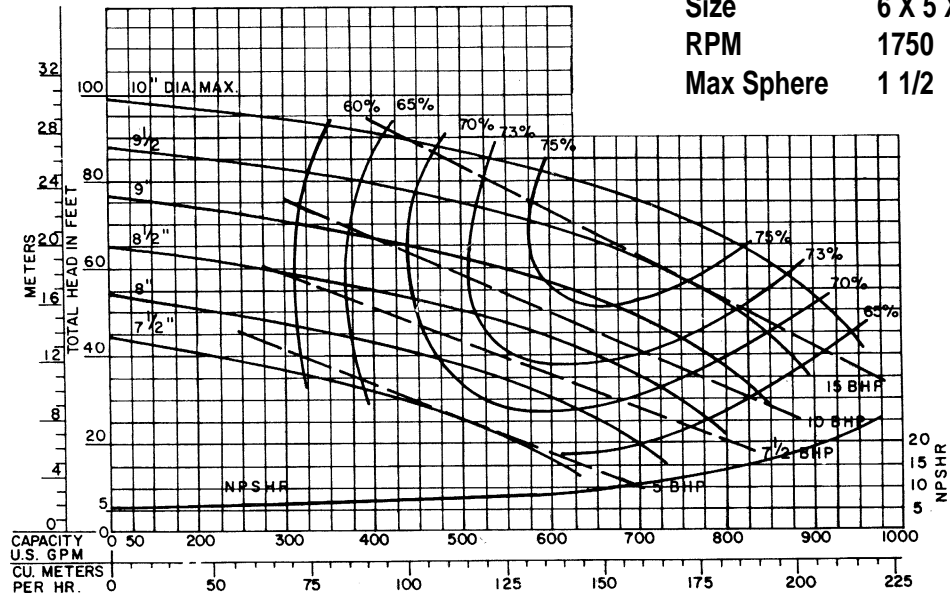

Curve SM-1850

Series 1300 / 1400
 Size 6 X 5 X 10A
 RPM 1150
 Max Sphere 1 1/2

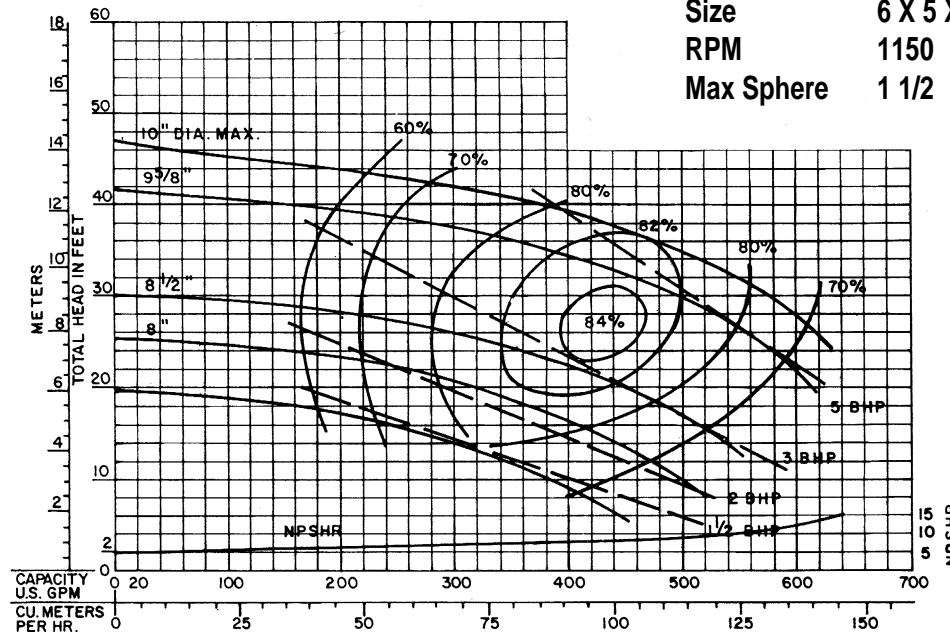

Performance at Casing Discharge Flange

Curves Show Performance with Liquid Having Specific Gravity 1.0 Viscosity • 30 SSU

CUSTOMER _____ CUSTOMER NO. _____

PROJECT _____

ENGINEER _____

CONTRACTOR _____

CONDITIONS: _____ GPM _____ TDH _____ HP _____ EFF% _____ IMP. DIA _____

VERTIFLO PUMP COMPANY Performance Curves

Curve TM-1760

Series 1300 / 1400
 Size 6 X 6 X 10
 RPM 1750
 Max Sphere 1 1/8

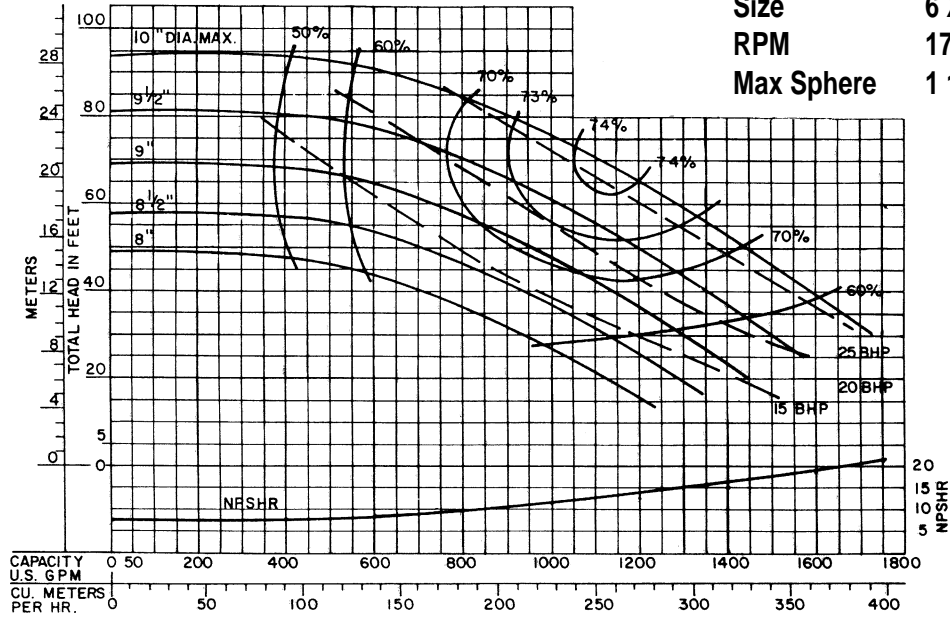

Curve UM-1760

Series 1300 / 1400
 Size 6 X 6 X 10
 RPM 1150
 Max Sphere 1 1/8

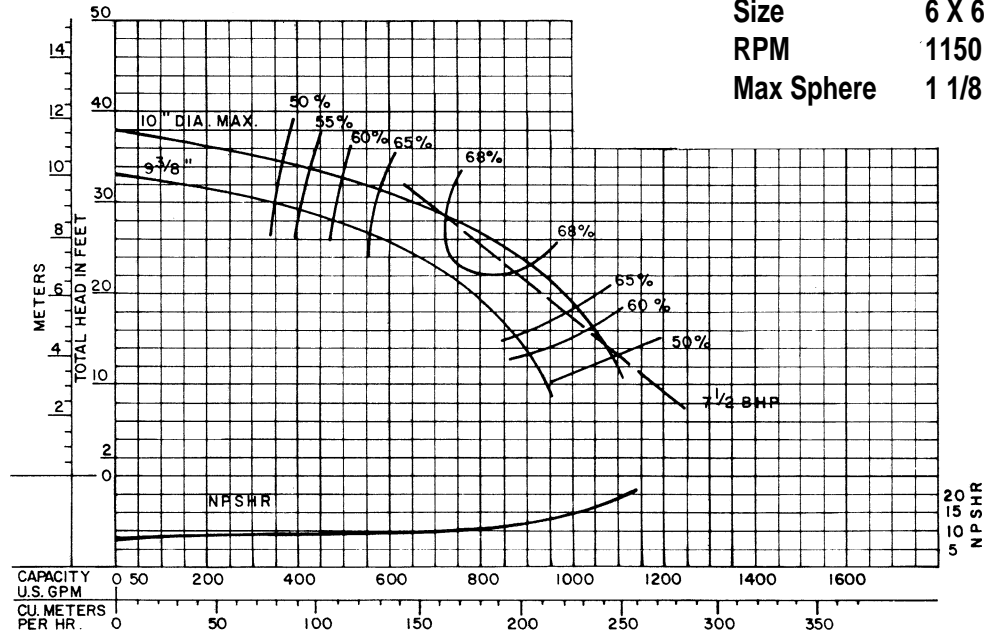

1300

Performance at Casing Discharge Flange

Curves Show Performance with Liquid Having Specific Gravity 1.0 Viscosity • 30 SSU

CUSTOMER _____ CUSTOMER NO. _____

PROJECT _____

ENGINEER _____

CONTRACTOR _____

CONDITIONS: _____ GPM _____ TDH _____ HP _____ EFF% _____ IMP. DIA _____

VERTIFLO PUMP COMPANY Performance Curves

Curve LM-1760

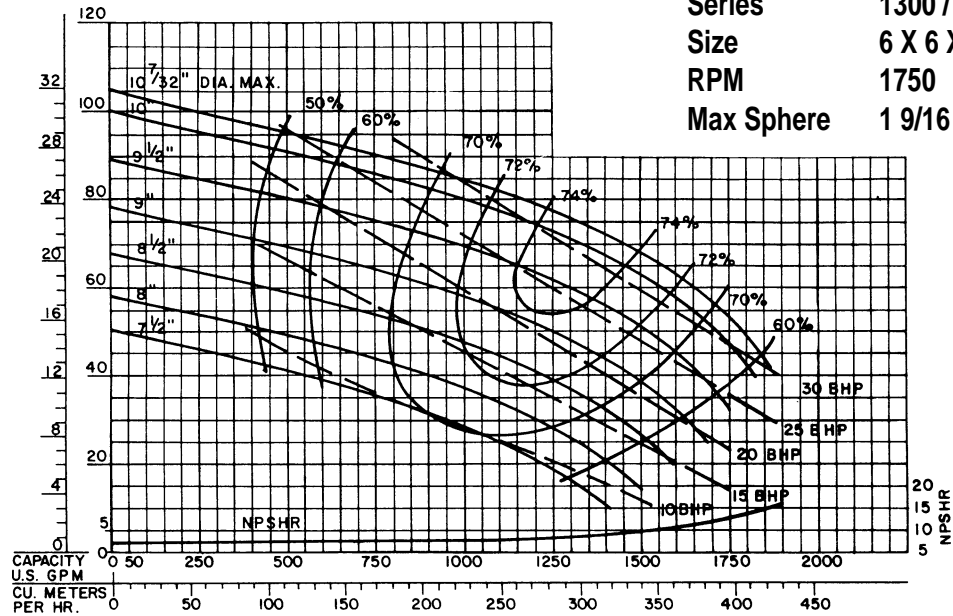

Curve LM-1860

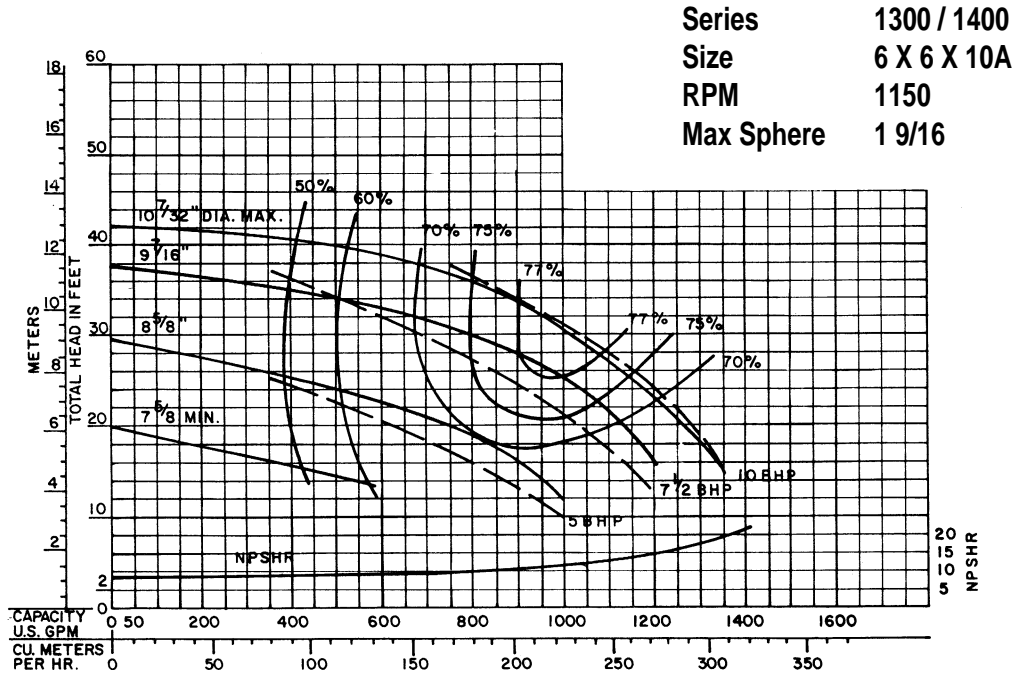

Performance at Casing Discharge Flange

Curves Show Performance with Liquid Having Specific Gravity 1.0 Viscosity • 30 SSU

CUSTOMER _____ CUSTOMER NO. _____

PROJECT _____

ENGINEER _____

CONTRACTOR _____

CONDITIONS: _____ GPM _____ TDH _____ HP _____ EFF% _____ IMP. DIA _____

VERTIFLO PUMP COMPANY Performance Curves

Curve KL-1915

Series 1300 / 1400
 Size 2 X 1 1/2 X 12
 RPM 1750
 Max Sphere 7/16

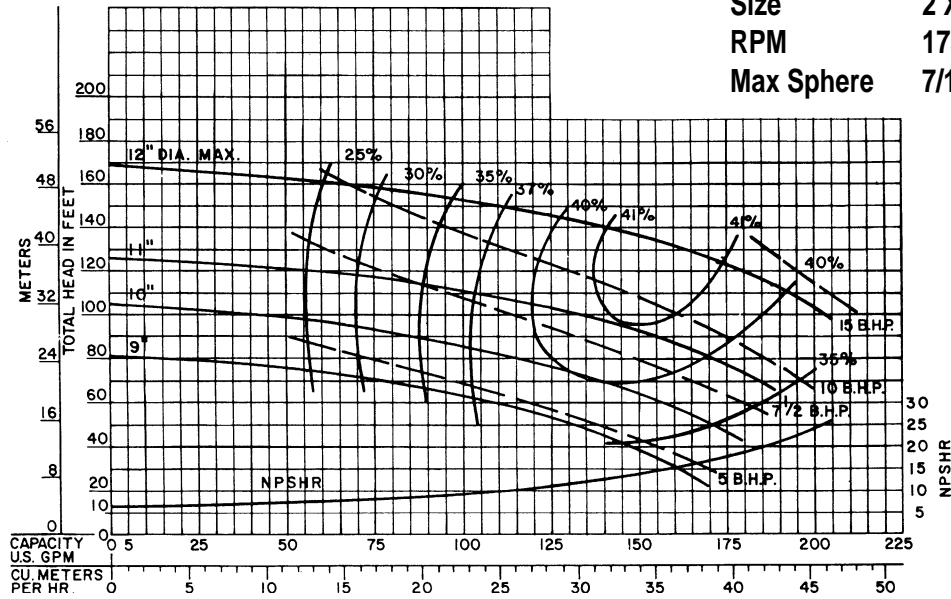

Curve LL-1915

Series 1300 / 1400
 Size 2 X 1 1/2 X 12
 RPM 1150
 Max Sphere 7/16

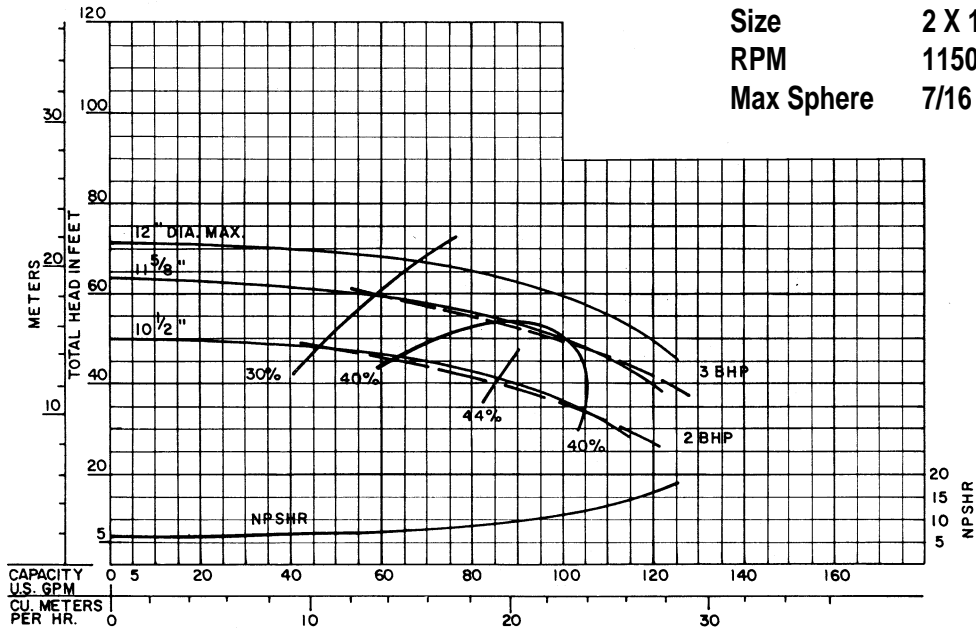

Performance at Casing Discharge Flange

Curves Show Performance with Liquid Having Specific Gravity 1.0 Viscosity • 30 SSU

CUSTOMER _____ CUSTOMER NO. _____

PROJECT _____

ENGINEER _____

CONTRACTOR _____

CONDITIONS: _____ GPM _____ TDH _____ HP _____ EFF% _____ IMP. DIA _____

1300

VERTIFLO PUMP COMPANY Performance Curves

Curve KL-1916

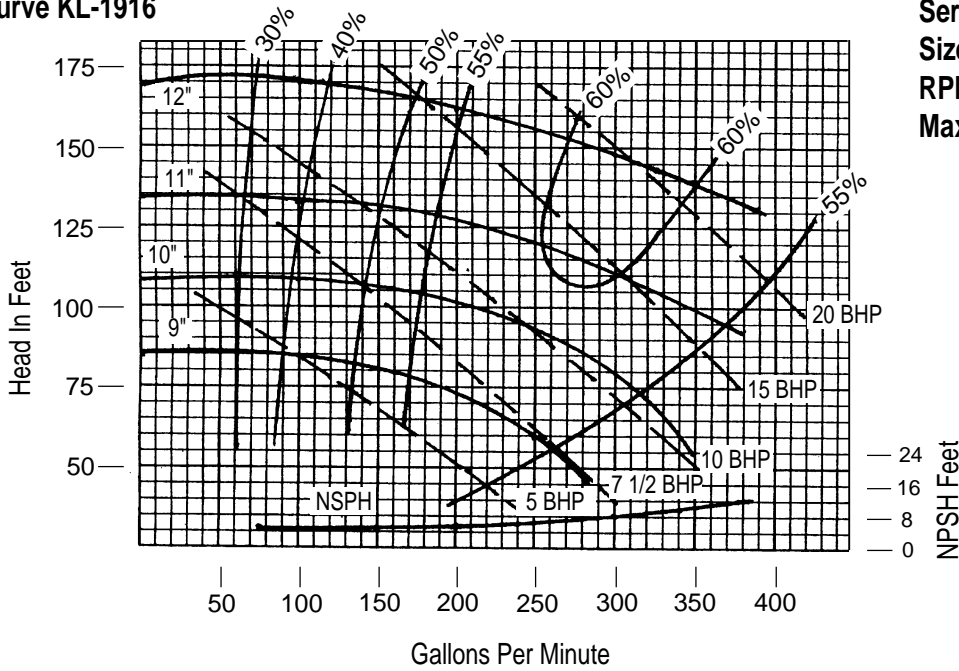

Curve LL-1916

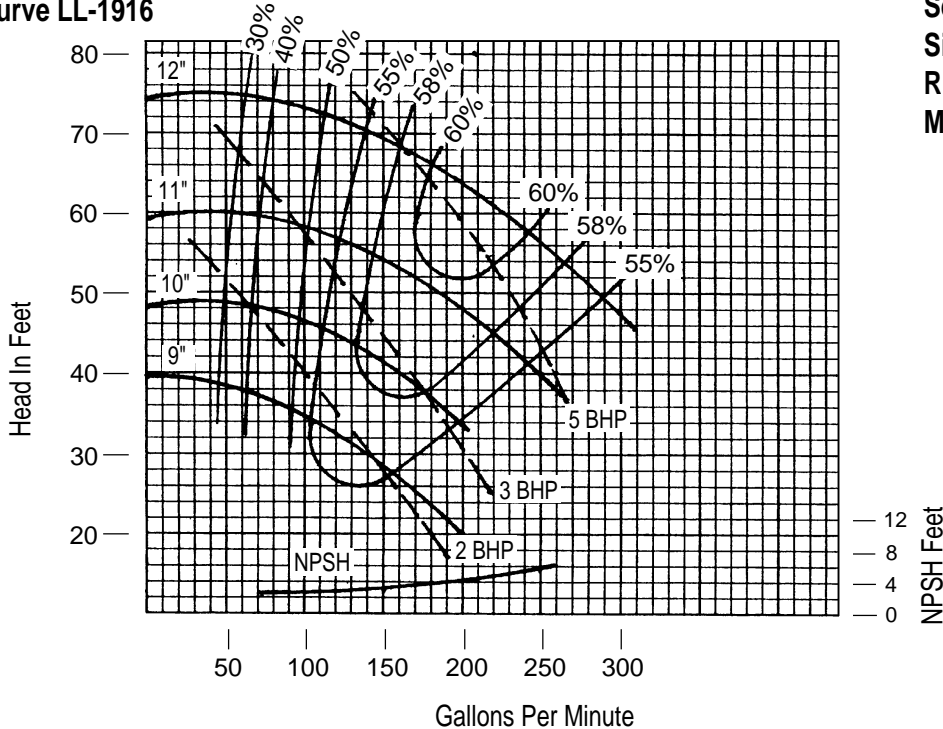

Performance at Casing Discharge Flange

Curves Show Performance with Liquid Having Specific Gravity 1.0 Viscosity • 30 SSU

CUSTOMER _____ CUSTOMER NO. _____

PROJECT _____

ENGINEER _____

CONTRACTOR _____

CONDITIONS: _____ GPM _____ TDH _____ HP _____ EFF% _____ IMP. DIA _____

VERTIFLO PUMP COMPANY Performance Curves

Curve KL-1917

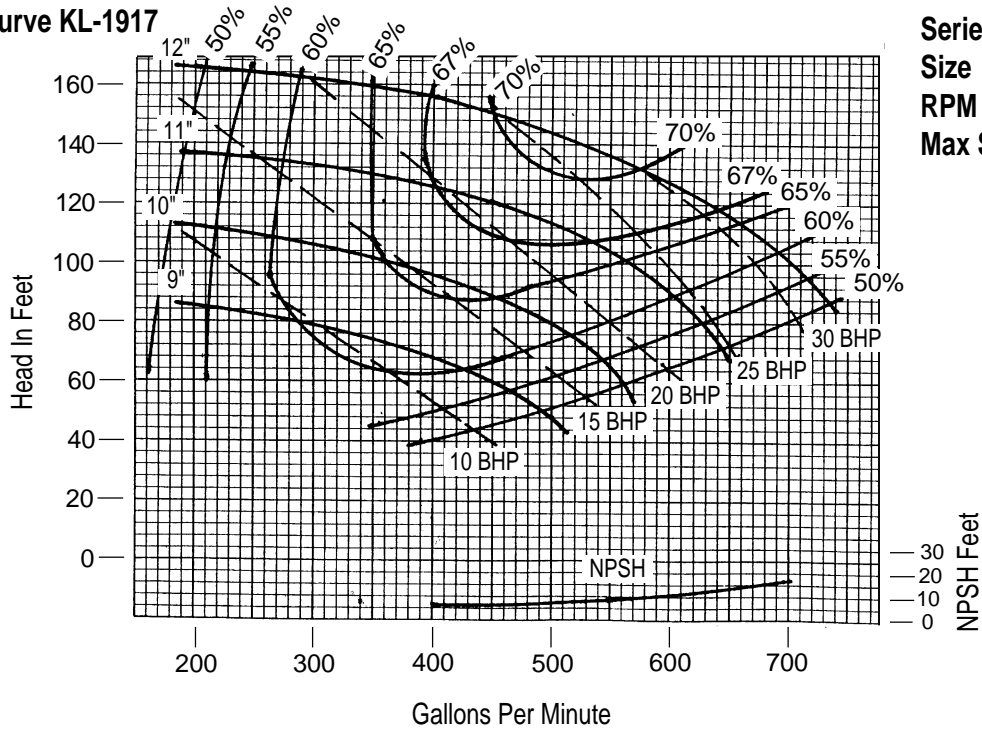

Series 1300 / 1400
Size 4 X 3 X 12
RPM 1750
Max Sphere 1 1/4

Curve LL-1917

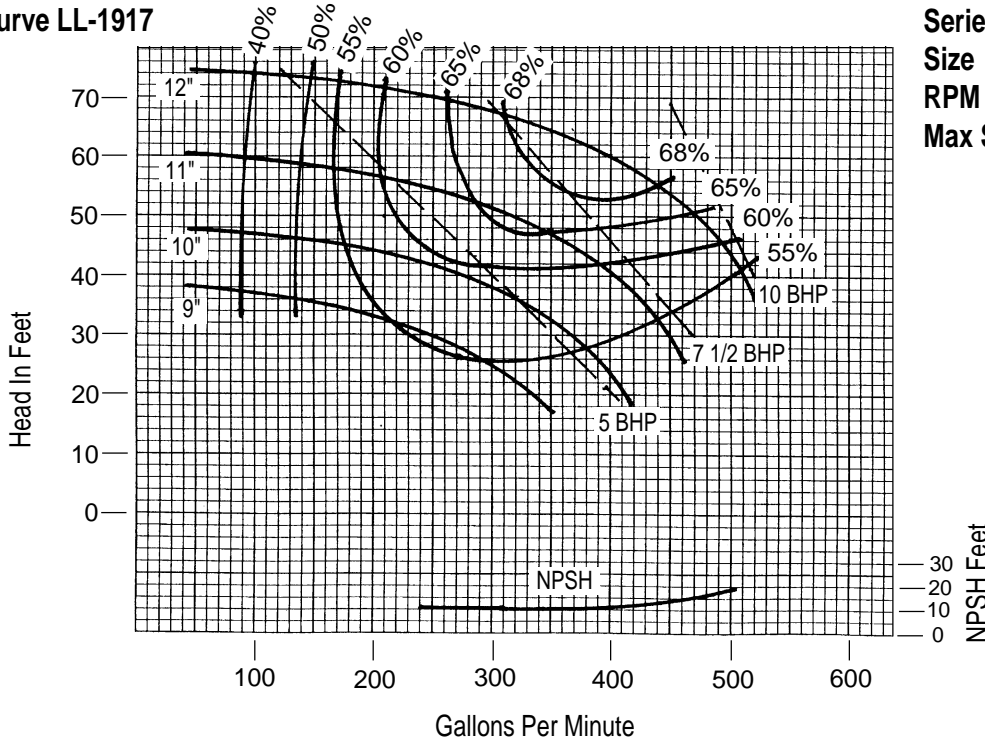

Series 1300 / 1400
Size 4 X 3 X 12
RPM 1150
Max Sphere 1 1/4

Performance at Casing Discharge Flange

Curves Show Performance with Liquid Having Specific Gravity 1.0 Viscosity • 30 SSU

CUSTOMER _____ CUSTOMER NO. _____

PROJECT _____

ENGINEER _____

CONTRACTOR _____

CONDITIONS: _____ GPM _____ TDH _____ HP _____ EFF% _____ IMP. DIA _____

1300

VERTIFLO PUMP COMPANY Performance Curves

Curve 64124

Series 1300 / 1400
 Size 6 X 4 X 12
 RPM 1750
 Max Sphere 1 1/2

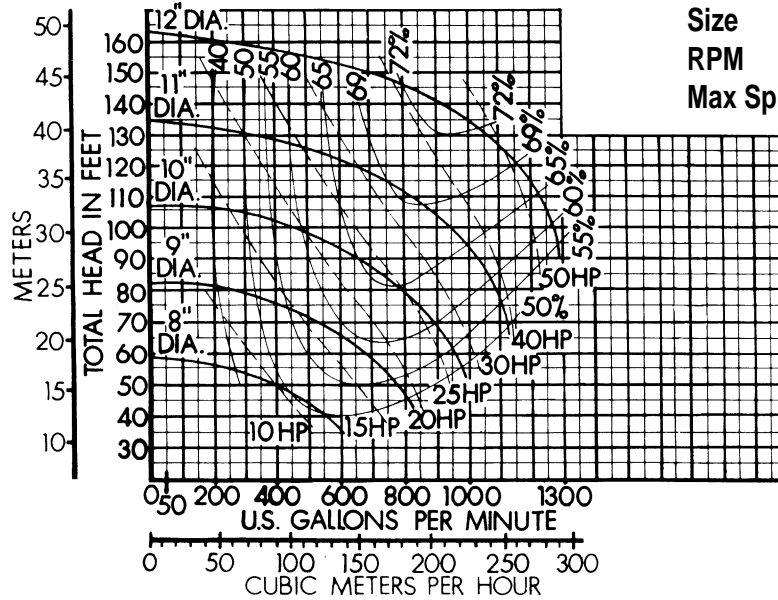

Curve 64126

Series 1300 / 1400
 Size 6 X 4 X 12
 RPM 1150
 Max Sphere 1 1/2

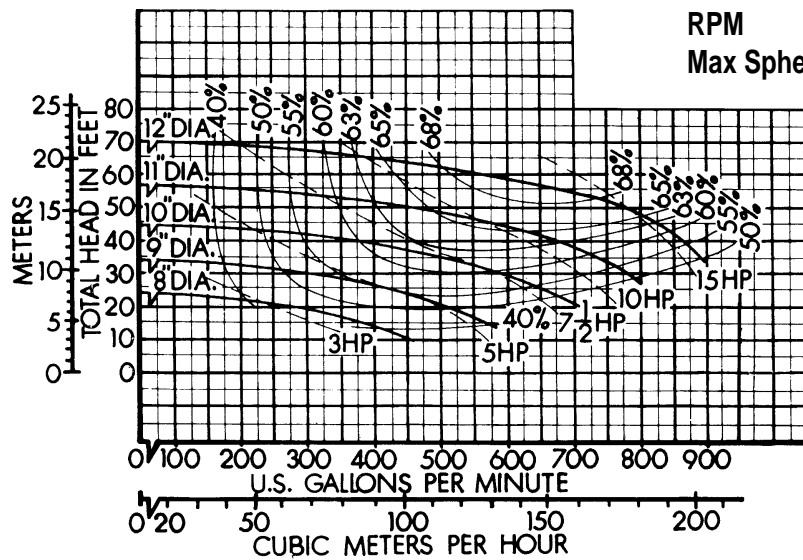

Performance at Casing Discharge Flange

Curves Show Performance with Liquid Having Specific Gravity 1.0 Viscosity • 30 SSU

CUSTOMER _____ CUSTOMER NO. _____

PROJECT _____

ENGINEER _____

CONTRACTOR _____

CONDITIONS: _____ GPM _____ TDH _____ HP _____ EFF% _____ IMP. DIA _____

VERTIFLO PUMP COMPANY Performance Curves

Curve 6412A4

Series 1300 / 1400
 Size 6 X 4 X 12A
 RPM 1750
 Max Sphere 1 1/8

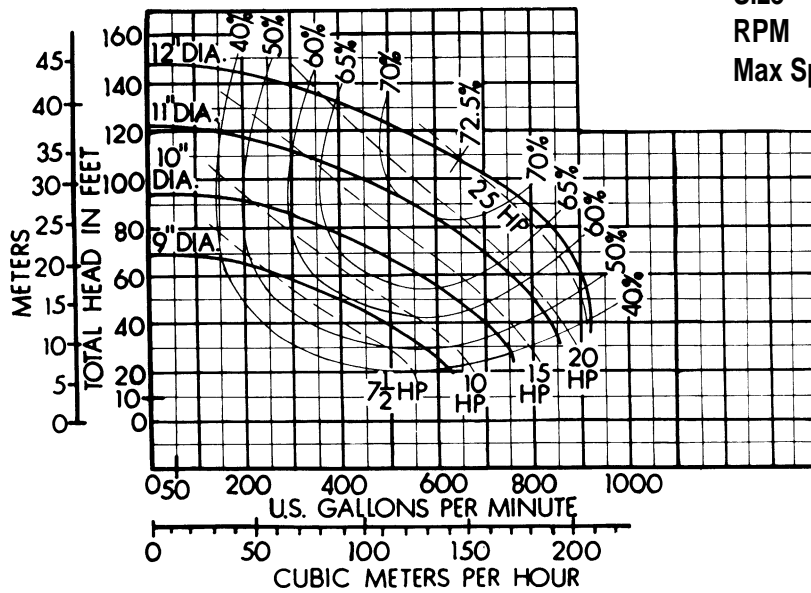

Curve 6412A6

Series 1300 / 1400
 Size 6 X 4 X 12A
 RPM 1150
 Max Sphere 1 1/8

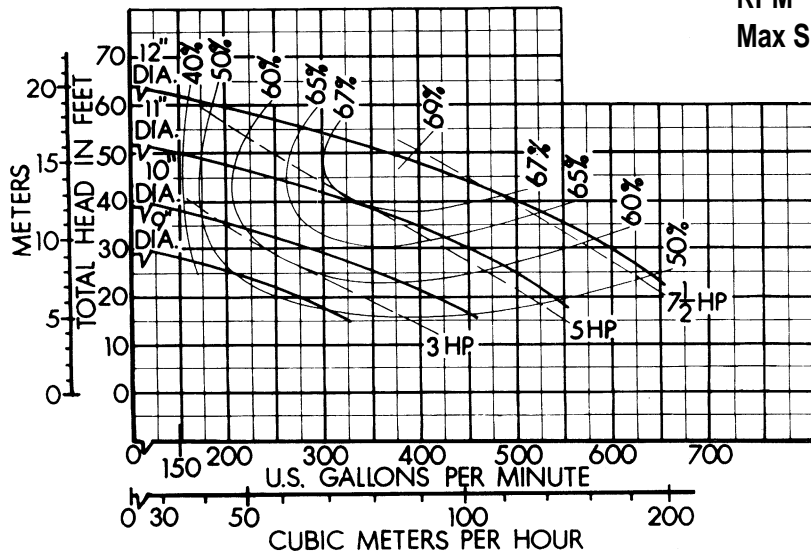

1300

Performance at Casing Discharge Flange

Curves Show Performance with Liquid Having Specific Gravity 1.0 Viscosity • 30 SSU

CUSTOMER _____ CUSTOMER NO. _____

PROJECT _____

ENGINEER _____

CONTRACTOR _____

CONDITIONS: _____ GPM _____ TDH _____ HP _____ EFF% _____ IMP. DIA _____

VERTIFLO PUMP COMPANY Performance Curves

Curve 66124

Series 1300 / 1400
 Size 6 X 6 X 12
 RPM 1750
 Max Sphere 1 1/2

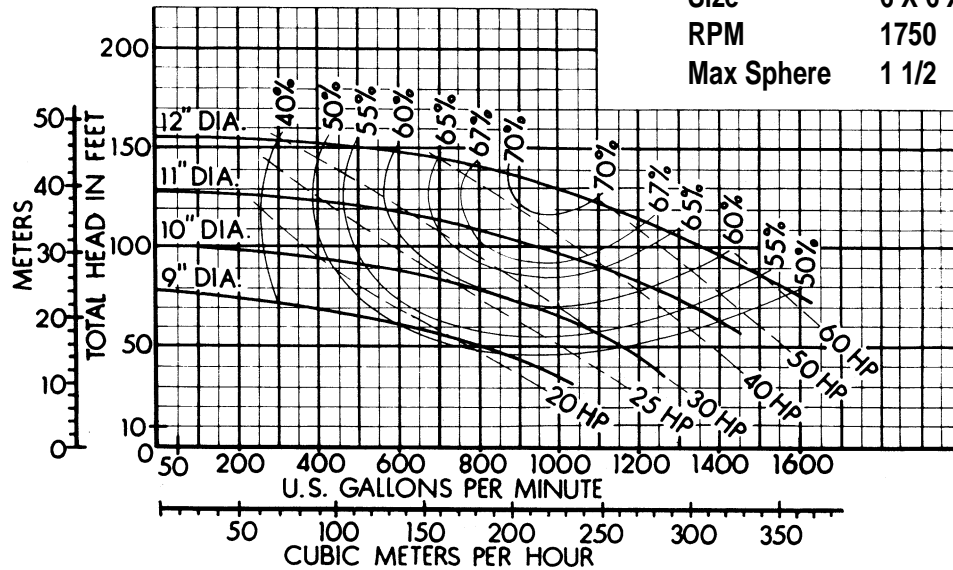

Curve 66126

Series 1300 / 1400
 Size 6 X 6 X 12
 RPM 1150
 Max Sphere 1 1/2

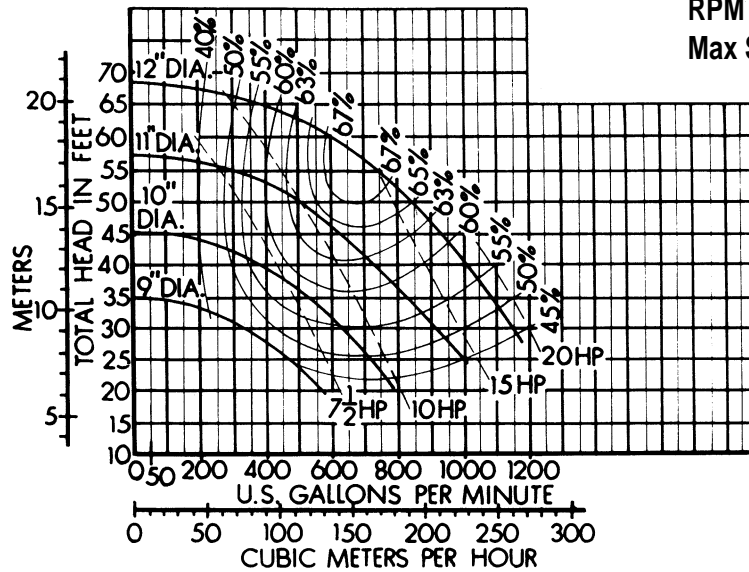

Performance at Casing Discharge Flange

Curves Show Performance with Liquid Having Specific Gravity 1.0 Viscosity • 30 SSU

CUSTOMER _____ CUSTOMER NO. _____

PROJECT _____

ENGINEER _____

CONTRACTOR _____

CONDITIONS: _____ GPM _____ TDH _____ HP _____ EFF% _____ IMP. DIA _____

VERTIFLO PUMP COMPANY

Curve 88124

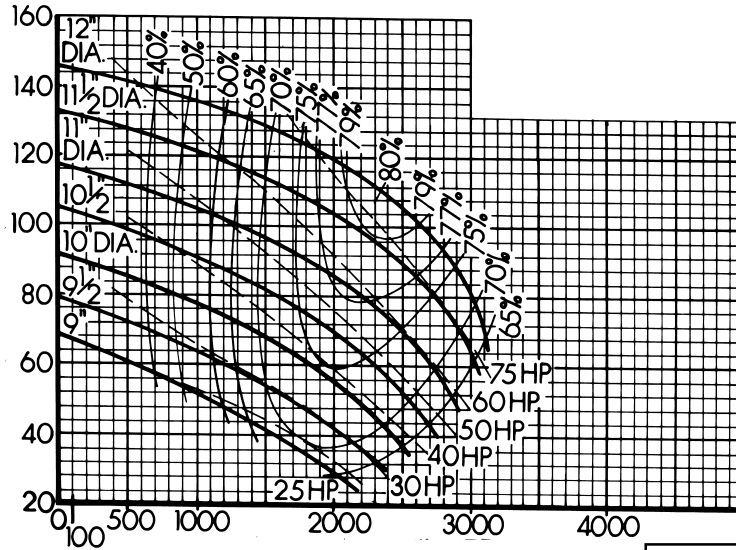

Series 1300 / 1400
 Size 8 X 8 X 12
 RPM 1750
 Max Sphere 1 1/2



Curve 88126

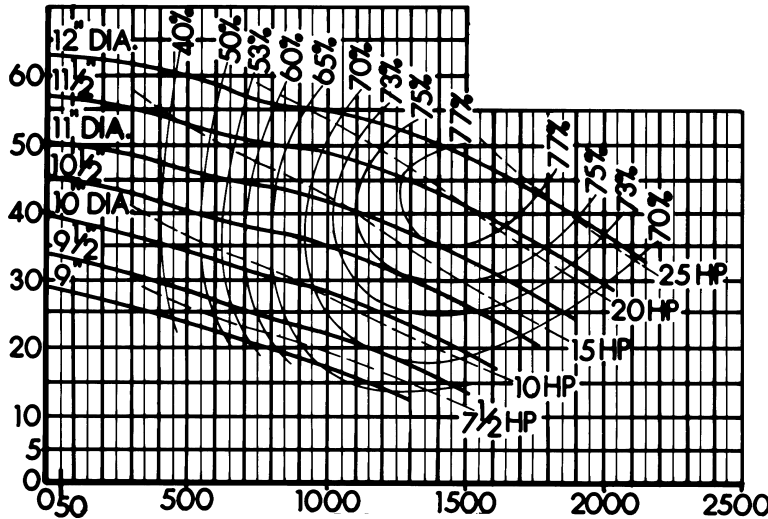

Series 1300 / 1400
 Size 8 X 8 X 12
 RPM 1150
 Max Sphere 1 1/2

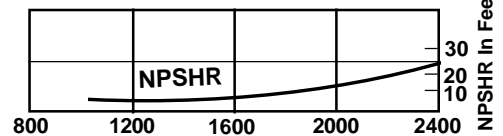

1300

Performance at Casing Discharge Flange

Curves Show Performance with Liquid Having Specific Gravity 1.0 Viscosity • 30 SSU

CUSTOMER _____ CUSTOMER NO. _____

PROJECT _____

ENGINEER _____

CONTRACTOR _____

CONDITIONS: _____ GPM _____ TDH _____ HP _____ EFF% _____ IMP. DIA _____

VERTIFLO PUMP COMPANY

Curve 101012

Series 1300 / 1400
 Size 10 X 10 X 12
 RPM 1750
 Max Sphere 1 1/2

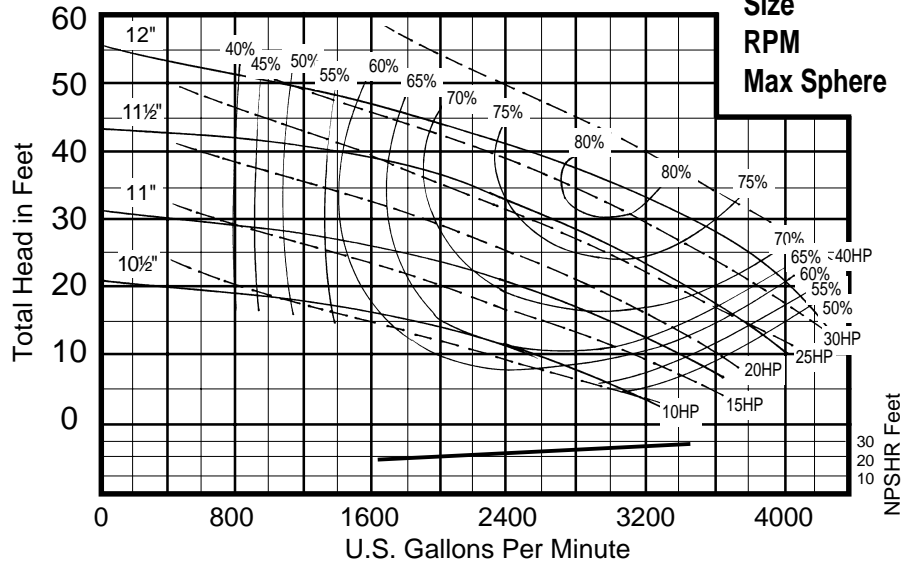

Performance at Casing Discharge Flange

Curves Show Performance with Liquid Having Specific Gravity 1.0 Viscosity • 30 SSU

CUSTOMER _____ CUSTOMER NO. _____

PROJECT _____

ENGINEER _____

CONTRACTOR _____

CONDITIONS: _____ GPM _____ TDH _____ HP _____ EFF% _____ IMP. DIA _____

VERTIFLO PUMP COMPANY Performance Curves

Curve 3272

Series 1300 / 1400
 Size 3 X 2 1/2 X 7
 RPM 3500
 Max Sphere 1

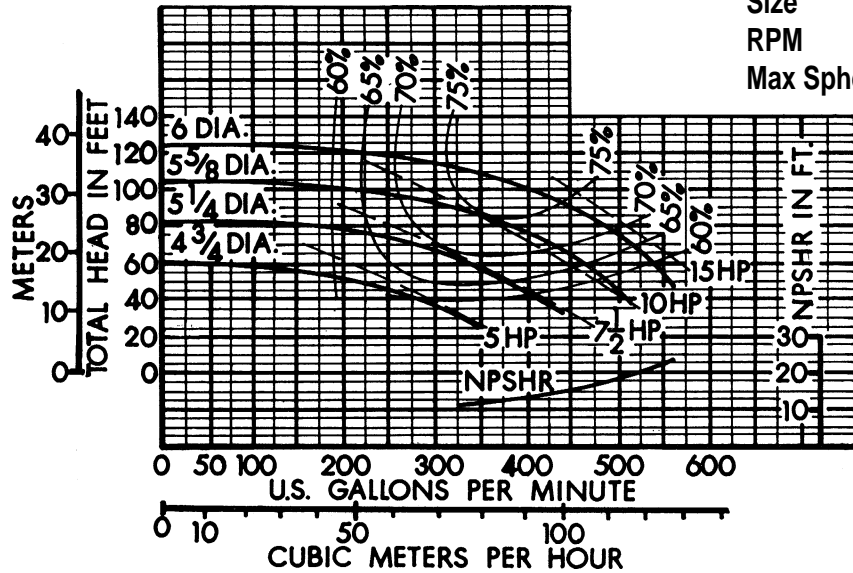

Curve 11082

Series 1300 / 1400
 Size 1 1/2 X 1 X 8
 RPM 3500
 Max Sphere 1/4

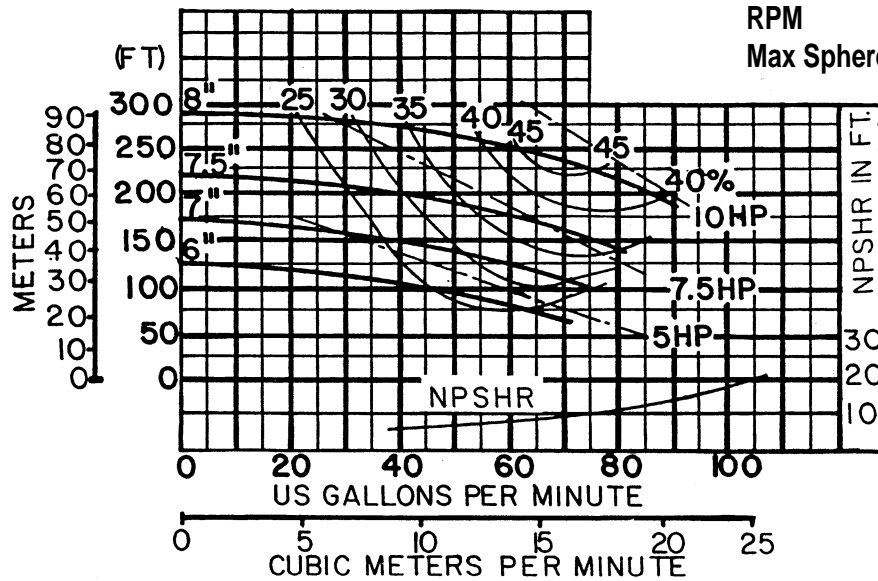

Performance at Casing Discharge Flange

Curves Show Performance with Liquid Having Specific Gravity 1.0 Viscosity • 30 SSU

CUSTOMER _____ CUSTOMER NO. _____

PROJECT _____

ENGINEER _____

CONTRACTOR _____

CONDITIONS: _____ GPM _____ TDH _____ HP _____ EFF% _____ IMP. DIA _____

1300

VERTIFLO PUMP COMPANY Performance Curves

Curve 11092

Series 1300 / 1400
 Size 1 1/2 X 1 1/4 X 8
 RPM 3500
 Max Sphere 5/16

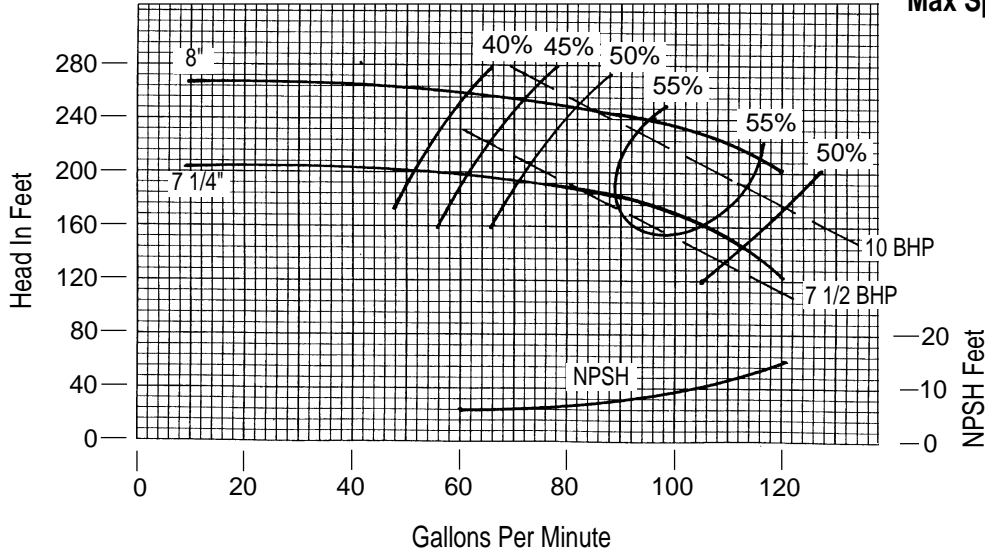

Performance at Casing Discharge Flange

Curves Show Performance with Liquid Having Specific Gravity 1.0 Viscosity • 30 SSU

CUSTOMER _____ CUSTOMER NO. _____

PROJECT _____

ENGINEER _____

CONTRACTOR _____

CONDITIONS: _____ GPM _____ TDH _____ HP _____ EFF% _____ IMP. DIA _____

VERTIFLO PUMP COMPANY Performance Curves

Curve 2182

Series 1300 / 1400
 Size 2 X 1 1/2 X 8
 RPM 3500
 Max Sphere 7/16

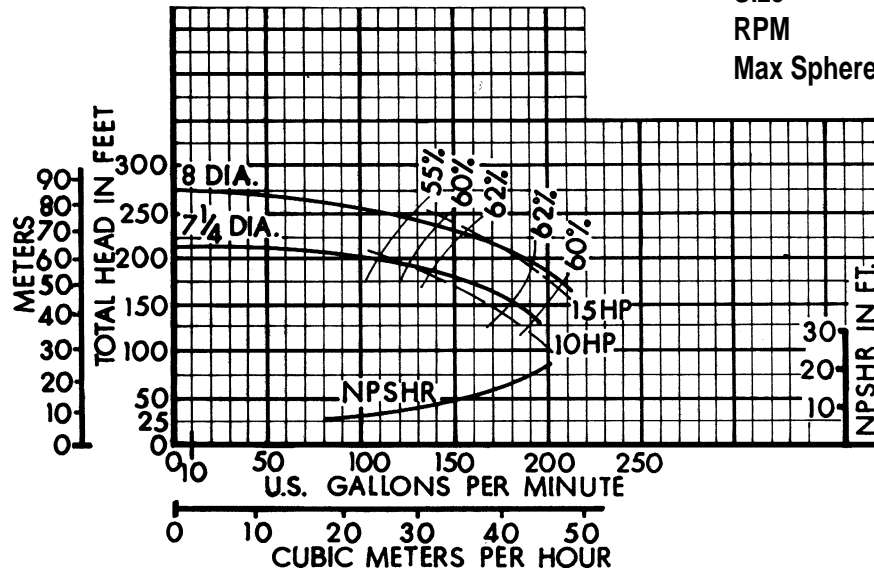

Curve 3282

Series 1300 / 1400
 Size 3 X 2 X 8
 RPM 3500
 Max Sphere 11/16

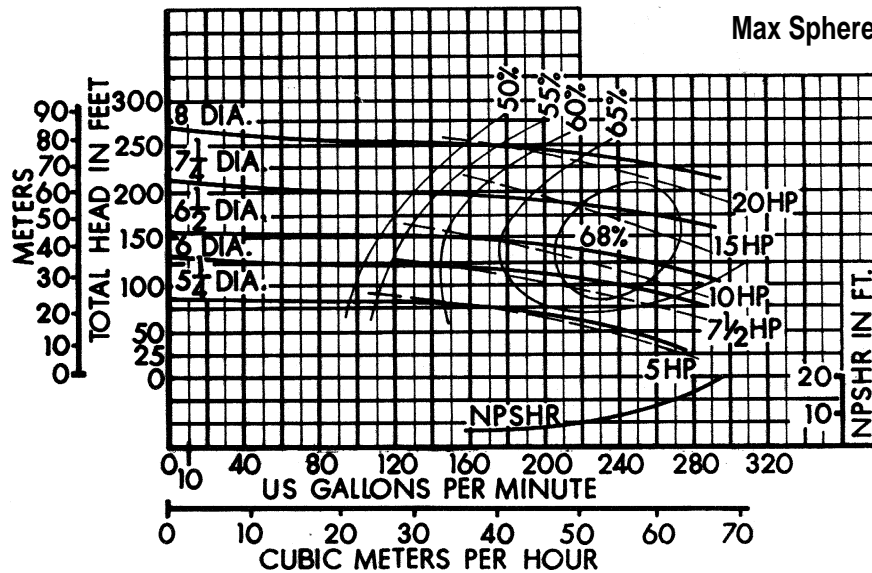

Performance at Casing Discharge Flange

Curves Show Performance with Liquid Having Specific Gravity 1.0 Viscosity • 30 SSU

CUSTOMER _____ CUSTOMER NO. _____

PROJECT _____

ENGINEER _____

CONTRACTOR _____

CONDITIONS: _____ GPM _____ TDH _____ HP _____ EFF% _____ IMP. DIA _____

1300

VERTIFLO PUMP COMPANY Performance Curves

Curve 32102

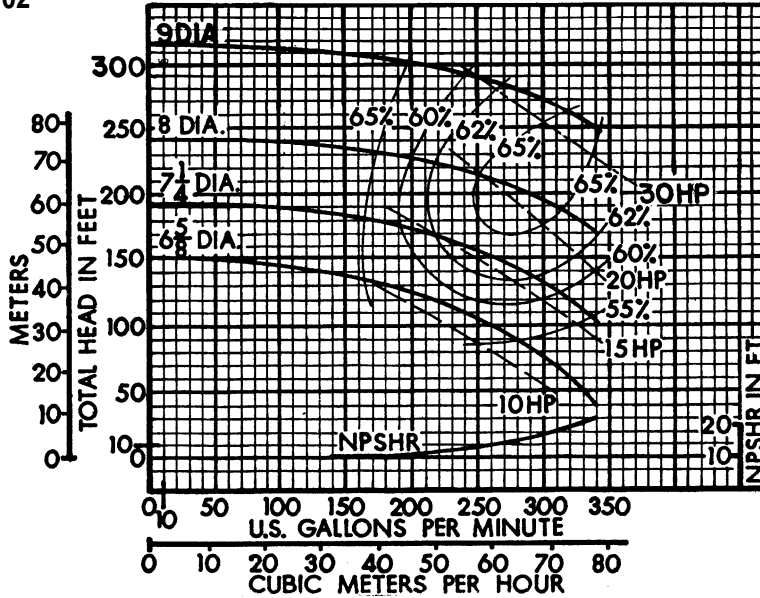

Series 1300 / 1400
 Size 3 X 2 X 10
 RPM 3500
 Max Sphere 11/16

Curve 11082

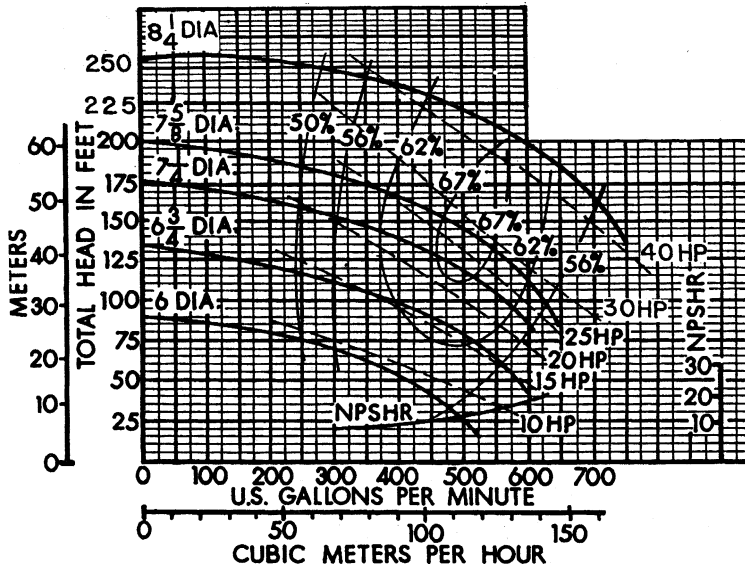

Series 1300 / 1400
 Size 4 X 3 X 10
 RPM 3500
 Max Sphere 1 3/16

Performance at Casing Discharge Flange

Curves Show Performance with Liquid Having Specific Gravity 1.0 Viscosity • 30 SSU

CUSTOMER _____ CUSTOMER NO. _____

PROJECT _____

ENGINEER _____

CONTRACTOR _____

CONDITIONS: _____ GPM _____ TDH _____ HP _____ EFF% _____ IMP. DIA _____

1300 Series - 8" Line

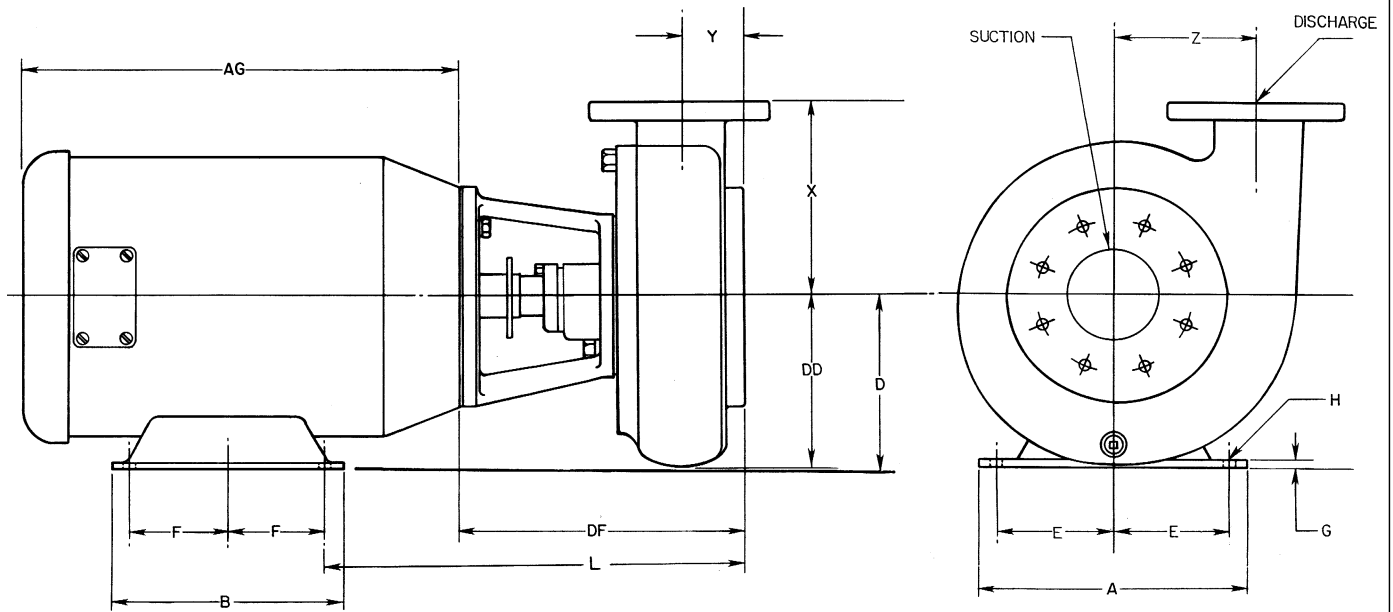

MOTOR DATA

FRAME	A	B	D	E	F	G	H	AG
143 JP	6½	6	3½	2¾	2	1/8	11/32	97/16
145 JP	6½	6	3½	2¾	2½	1/8	11/32	97/16
182 JP	8¾	6¾	4½	3¾	2¼	3/8	13/32	13½
184 JP	8¾	6¾	4½	3¾	2¾	3/8	13/32	13½
213 JP	9½	7¾	5¼	4¼	2¾	5/8	13/32	15½
215 JP	9½	8¾	5¼	4¼	3½	5/8	13/32	17
254 JP	11¾	10 11/16	6¼	5	4½	11/16	17/32	20 1/8
256 JP	11¾	12 7/16	6¼	5	5	11/16	17/32	21 7/8
284 JP	12 7/8	12¼	7	5½	4¾	¾	17/32	22 3/8

Dimensions Based on TEFC, JP Frame Motors.

Not for construction unless certified, some dimensions may vary ± 1/2". Pump Construction: _____

CUSTOMER _____ CUSTOMER NO. _____
 PROJECT _____ SERIAL NO. _____
 ENGINEER _____ LOCATION _____
 CONTRACTOR _____
 PUMP Model _____ Size _____ Curve No. _____ GPM _____ Head _____ SP. GR. @Temp. _____
 DATA _____
 MOTOR Mfg. _____ HP _____ RPM _____ Volt-Phase-Cycle _____ Frame ENC. _____
 DATA _____
 Shop Order _____ Certified by _____ Date _____

1300

VERTIFLO PUMP COMPANY Dimensions

1300 Series - 8" Line

LIQUID END	PUMP MODEL	MOTOR FRAME	SUCTION FLANGE						DISCHARGE FLANGE						DF	L	X	Y	Z	DD	R ₁	R ₂
			FLG. SIZE	DIA. FLG.	# OF HOLES	HOLE DIA.	TAP	B.C.	FLG. SIZE	DIA. FLG.	# OF HOLES	HOLE DIA.	B.C.									
3 x 2½ x 7	1320	143 JP	3	7½	4	—	5/8	6	2½	7	4	¾	5½	10 9/16	13 3/16	6¼	2 2/8	4 ¾	5 ½			
		145 JP													13 5/16							
		182 JP													14 ¼							
		184 JP													14 ¼							
	1326	213 JP													11 1/8							15 1 1/16
		215 JP																				16 3/16
		254 JP																				16 3/16
1½ x 1 x 8	1320	143 JP	1½	5	4	—	½	3 7/8	1	4¼	4	5/8	3 3/8	9 3/8	12 1/16	6	1 5/8	4 ½	5 ¼			
		145 JP													11 13/16							
		182 JP													12 3/4							
		184 JP													12 3/4							
	1326	213 JP													9 5/16							14 ½
		215 JP																				14 ½
1½ x 1¼ x 8	1320	143 JP	1½	5	4	—	½	3 7/8	1¼	4 5/8	4	5/8	3 ½	9 3/16	13 5/16	5 ¾	1 13/16	4 ¾	5 3/8	5 ½	5 ¾	
		145 JP													13 1/16							
		182 JP													14							
		184 JP													14							
	1326	213 JP													9 ¾							15 7/16
		215 JP																				15 15/16
		254 JP																				15 15/16
		256 JP																				15 15/16
2 x 1½ x 8	1320	143 JP	2	6	4	—	5/8	4 ¾	1½	5	4	9/16	3 7/8	9 13/16	12 ¾	5 ¾	2	4 ¾	5 3/8			
		145 JP													12 ½							
		182 JP													13 7/16							
		184 JP													13 7/16							
	1326	213 JP													10 3/8							14 15/16
		215 JP																				14 15/16
3 x 2 x 8	1320	143 JP	2½	7	4	—	5/8	5½	2	6	4	¾	4 ¾	10 1/16	13	6¼	2 1/8	4 ¾	5 ¾			
		145 JP													12 ¾							
		182 JP													13 1 1/16							
		184 JP													13 1 1/16							
	1326	213 JP													10 5/8							15 3/16
		215 JP																				15 11/16
		254 JP																				15 11/16
		256 JP																				15 11/16
4 x 3 x 8	1320	145 JP	4	9	8	—	5/8	7½	3	7½	4	¾	6	11	13 ¾	7	2 ¾	5 ¼	6			
		182 JP													14 11/16							
		184 JP													14 11/16							
5 x 4 x 8	1320	145 JP	5	10	8	—	¾	8½	4	9	8	¾	7½	11 3/8	14 ¼	7	2 7/8	6	7 1/8			
		182 JP													15 1/16							
		184 JP													15 1/16							
	1326	213 JP												11 15/16	16 ½							
		215 JP													16 ½							

VERTIFLO PUMP COMPANY Dimensions

1300 Series - 10/12" Line

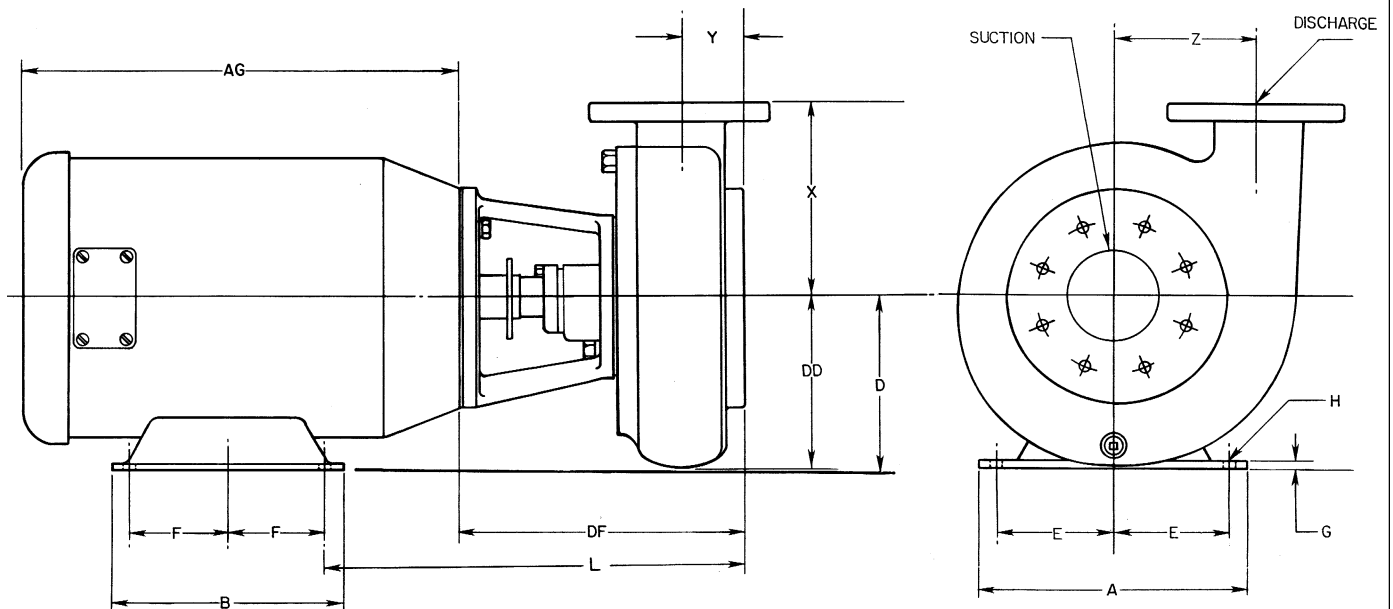

MOTOR DATA

FRAME	A	B	D	E	F	G	H	AG
143 JP	6½	6	3½	2¾	2	⅛	11/32	97/16
145 JP	6½	6	3½	2¾	2½	⅛	11/32	97/16
182 JP	8¾	6¾	4½	3¾	2¼	¾	13/32	13½
184 JP	8¾	6¾	4½	3¾	2¾	¾	13/32	13½
213 JP	9½	7¾	5¼	4¼	2¾	⅝	13/32	15½
215 JP	9½	8¾	5¼	4¼	3½	⅝	13/32	17
254 JP	11¾	10 1/16	6¼	5	4½	11/16	17/32	20 1/8
256 JP	11¾	12 7/16	6¼	5	5	1 1/16	17/32	21 1/8
284 JP	12 7/8	12 ¼	7	5 ½	4 ¾	¾	17/32	22 ¾
286 JP	12 7/8	13 ¾	7	5 ½	4 ¾	¾	17/32	23 7/8
324 JP	15 ¾	13 ½	8	6 ¼	5 ¼	1 1/8	2 1/32	24 11/16
326 JP	15 ¾	16	8	6 ¼	6	1 1/8	2 1/32	26 3/16
364 JP	17 ¾	14 ¼	9	7	5 5/8	1 ¼	2 1/32	26 9/16

Dimensions Based on TEFC, JP Frame Motors.

Not for construction unless certified, some dimensions may vary ± 1/2". Pump Construction: _____

CUSTOMER _____ CUSTOMER NO. _____
 PROJECT _____ SERIAL NO. _____
 ENGINEER _____ LOCATION _____
 CONTRACTOR _____
 PUMP Model _____ Size _____ Curve No. _____ GPM _____ Head _____ SP. GR. @Temp. _____
 DATA _____
 MOTOR Mfg. _____ HP _____ RPM _____ Volt-Phase-Cycle _____ Frame ENC. _____
 DATA _____
 Shop Order _____ Certified by _____ Date _____

VERTIFLO PUMP COMPANY Dimensions

1300 Series 10/12" Line

LIQUID END	PUMP MODEL	MOTOR FRAME	SUCTION FLANGE						DISCHARGE FLANGE						DF	L	X	Y	Z	DD
			FLG. SIZE	DIA. FLG.	# OF HOLES	HOLE DIA.	TAP	B.C.	FLG. SIZE	DIA. FLG.	# OF HOLES	HOLE DIA.	B.C.							
2x1½x10	1320	145 JP	2	6	4	—	5/8 11	4¾	1½	5	4	5/8	3¾	9 11/16	12 7/16	6 1/2	2	5 3/4	6 3/8	
		182 JP													13 3/8					
		184 JP													14 13/16					
	1326	213 JP												10 1/4						
		215 JP												15 5/16						
		254 JP																		
		256 JP																		
3x2x10	1320	145 JP	3	7 1/2	4	—	5/8 11	6	2	6	4	¾	4¾	10 1/16	12 3/4	7	2 1/8	5 3/4	6 1/2	
		182 JP													13 1 1/16					
		184 JP																		
	1326	213 JP												15 3/16						
		215 JP												10 5/8						
		254 JP																		
		256 JP												15 1 1/16						
4x3x10	1320	145 JP	4	9	8	—	5/8 11	7 1/2	3	7 1/2	4	¾	6	10 5/8	13 5/16	8 3/8	2 7/16	6 1/4	7	
		182 JP													14 1/4					
		213 JP													15 3/4					
	1326	215 JP												11 1/4						
		254 JP												16 1/4						
		256 JP																		
		284 JP																		
5x4x10	1320	184 JP	5	10	8	—	¾ 10	8 1/2	4	9	8	¾	7 1/2	11 3/16	14 13/16	9	2 3/4	6 1/2	7 1/2	
		213 JP												16 3/8						
	1326	215 JP												11 3/4						
		254 JP												16 7/8						
		256 JP																		
6x5x10 6x5x10A	1320	145 JP	6	11	8	—	¾ 10	9 1/2	5	10	8	7/8	8 1/2	11 5/16	13 7/8	9	2 13/16	7 1/8	8 3/8	
		182 JP												14 13/16						
	1326	213 JP												16 7/16						
		215 JP												11 7/8						
		254 JP												16 15/16						
		256 JP																		
		284 JP																		
6x6x10 6x6x10A	1326	215 JP	6	11	8	—	¾ 10	9 1/2	6	11	8	7/8	9 1/2	12 3/16	16 3/4	9	2 15/16	8	10	
		254 JP												17 1/4						
		256 JP																		
		284 JP																		
2x1½x12	1320	184 JP	2	6	4	¾	—	4¾	1½	5	4	5/8	3¾	11 1/2	15	7 1/2	3¾	6¾	3 7/8	
		213 JP												16 1/2						
	1326	215 JP												12 1/16						
		254 JP												17						

VERTIFLO PUMP COMPANY Dimensions

LIQUID END	PUMP MODEL	MOTOR FRAME	SUCTION FLANGE						DISCHARGE FLANGE					DF	L	X	Y	Z	DD
			FLG. SIZE	DIA. FLG.	# OF HOLES	SOLE DIA.	TAP	B.C.	FLG. SIZE	DIA. FLG.	# OF HOLES	SOLE DIA.	B.C.						
3x2x12	1326	213 JP	3	7½	4	—	⅝	6	2	6	4	¾	4¾	12½	16⅝	9½	2⅝	5	7⅝
		215 JP																	
		254 JP																	
		256 JP																	
		284 JP																	
4x3x12	1326	215 JP	4	9	8	—	⅝	7½	3	7½	4	¾	6	11¾	16¼	8½	2½	7¾	8½
		254 JP																	
		256 JP																	
		284 JP																	
		286 JP																	
6x4x12	1326	254 JP	6	11	8	—	¾	9½	4	9	8	⅞	7½	12¼	17¼	9	2¾	7¾	9
		256 JP																	
		284 JP																	
		286 JP																	
		324 JP																	
		326 JP																	
	1334	364 JP													18⅝				
6x6x12	1326	256 JP	6	11	8	—	¾	9½	6	11	8	¾	9½	13	18	9	3¼	8¾	9¾
		284 JP																	
		286 JP																	
		324 JP																	
		326 JP																	
	1334	364 JP													18½				
8x8x12	1326	256 JP	8	13½	8	—	¾	11¾	8	13½	8	¾	11¾	14½	19½	11	4½	10½	13¾
		284 JP																	
		286 JP																	
		324 JP																	
		326 JP																	
	1334	364 JP													20				
10x10x12	1326	256 JP	10	16	12	—	⅞	14¼	10	16	12	⅞	14¼	16½	21½	11	5½	10¾	13¾
		284 JP																	
		286 JP																	
		324 JP																	
		326 JP																	
	1334	364 JP													22				
														22⅝					

Dimension DF will be larger on frame 364 and larger.

VERTIFLO PUMP COMPANY

Intentionally Left Blank